

39-Years experienced special long distance CCTV systems

Up to 30km, 15km, 5km, 2.5km, True color-Day/Night-1km by 2-strong "IR" illuminator

Built-in MPEG-4/IP PTZ server to use DVD level Real-time image display with P/T/Z Control & Wiper on-off, Speaking, Alarm indication by client PC (1,4,8,9,16CH. Multi-screen display with PTZ control Software program by F.O.C)

" Special applications"

Intruder identification & motion tracking to use Defense of Borderline, Sea-side, airport, seaport, DAM, Weapon area, Oil pumping area by using Robot CCTV system

- YPZ-5000WS series (+) YIO-200 (+) YPS-600 / YPR-50.



- ◎ Quick reference chart of D/N image pick-up distance ----- P 2
- ◎ Day-30KM(90,000Ft), 15KM(45,000Ft), 5KM(15,000Ft), 2.5KM(7,500Ft) true color/Night-100M(300Ft), 200M(600Ft), 300M(900Ft), 500M(1,500Ft), 1KM(3,000Ft), 2KM(6,000Ft) B/W night vision by strong "IR" beam illuminator, Laser IR illuminator & motorized D/N filter about 10.0 lux at night automatically ----- P 3~10
- ◎ 360° Endless high speed Pan/Tilt/Motorized Zoom/64-preset/8x8 Group display true color Day-Night Cameras & systems (IP66, 30 Kg), Quad IR beam intruder identification sensor ----- P 3
- ◎ 350° Heavy duty or Medium duty Pan/Tilt driver with motorized Zoom D/N color camera (IP66) ----- P 4~6, 10
- ◎ 350° Stainless steel or explosion-proof Pan/Tilt driver with motorized Zoom Camera to use chemical plant, dangerous area (IP66, 20Kg) ----- P 8, 9
- ◎ Strong or wide angle "IR" Beam illuminator with CdS sensor & Laser "IR" illuminator ----- P 11
- ◎ Network video server to use long distance remote control by client PC & standalone decoder with PTZ control P 15
- ◎ MPEG-4 Real time standalone DVR-16CH. 9CH. 4CH. - Built-in DDNS Network Video server ----- P15
- ◎ MJPEG, 4CH. Mobil vision DVR or Economic 4CH. Standalone DVR with DDNS Network Video server ----- P15
- ◎ 540TV Lines C/CS mount Box or Bullet, Dome type true color D/N-20M, 30M, 50M, 100M, 200M image pick-up at night by using wide angle Power "IR" illuminator together ----- P17~18
- ◎ 360° Endless Speed dome P/T/Z/128-preset/Group, Pattern display, Built-in MPEG-4 A/V server ----- P12~13
- ◎ 3.25~88mm(27x) Auto Zoom true color D/N-0.0001 lux, Box, Bullet, Vandal dome ----- P14
- ◎ MAX. 255-P/T/Z/128-Preset/Group, pattern joystick remote controller or wireless Remocon ----- P14
- ◎ Environmental housing wide angle "IR" illuminator with motorized Zoom D/N-100M(300Ft) image pick-up color cameras (IP66, DC12V) ----- P19
- ◎ True color D/N-10M, 20M, 30M, 50M, 100M, 200M image pick-up color camera ----- P19~20
- ◎ Economic "IR" filter D/N-10M, 20M, 30M, 50M, 100M image pick-up color camera ----- P20~21
- ◎ 0.0001 Lux Star Light Sensitivity D/N color Cameras - Bullet, Dome, C/CS BOX, etc. ----- P22~23
- ◎ 100% Under-water cameras & 10M, 30M, 50M, 100M, 200M-water proof cable (IP68) ----- P23~24
- ◎ Power Zoom Magnification color camera to use Low vision or visually impaired ----- P24~25
- ◎ Additional items: 8CH. Matrix switcher, Digital motion detector, 14"/21" Color Monitor, etc ----- P25~26
- ◎ Accessories: Y-cable, W-cable, DC/RCA cable, Mounting Bracket ----- P26

Quick reference chart of D/N image pick-up distance

Model No		Image pick-up distance at Day (D) & Night (N)											
		10M	30M	50M	100M	300M	500M	1KM	2.5KM	5KM	1 5KM	30KM	
YPZ-3000W/5000WS-3000WAMTFH-101000/202000 (+)2-YIL-5000FH-28SS(±5°)	D	—————→											
	N	—————→ YLI-1000 YLI-5000											
YPZ-3000W/5000WS-3000WAMTFH-12750/251500 (+)2-YIL-5000FH-28SS(±5°)	D	—————→											
	N	—————→ YLI-1000 YLI-5000											
YPZ-3000W/5000WS-3000WAMTFH-10300 (+)2-YIL-5000FH-28SS(±5°)	D	—————→											
	N	—————→ YLI-1000 YLI-5000											
YPZ-3000W/5000WS-3000WAMTFH-10200 (+)2-YIL-5000FH-28SS(±5°)	D	—————→											
	N	—————→ YLI-1000 YLI-5000											
YPZ-1000W-1000DNFH-7SS(±5°)	D	—————→											
	N	—————→											
YPZ-3000W/5000WS-2700DNFH-21SS(±5°) (+)2-YIL-5000FH-28SS(±5°)	D	—————→											
	N	—————→											
YPZ-3000W-2700DNFH-28SS(±5°) (+)2-YIL-5000FH-28SS(±5°)	D	—————→											
	N	—————→											
YPZ-3000W-2700DNFH-250DS(±8°) (+)2-YIL-1000FH-264DS(±8°)	D	—————→											
	N	—————→											
YPZ-7000WFH-2700AMT-10200 (+)2-YIL-5000FH-28SS(±5°)	D	—————→											
	N	—————→											
YPZ-7000WFH-2700DN (+)2-YIL-5000FH-28SS(±5°)	D	—————→											
	N	—————→											
YPZ-9000WFH-2700DN (+)YIL-5000FH-28SS(±5°)	D	—————→											
	N	—————→											
YPZ-9000WFH-2700AMTFH-10200 (+)YIL-5000FH-28SS(±5°)	D	—————→											
	N	—————→											
YPZ-1000W-940DNFH-94DS(±8°)	D	—————→											
	N	—————→											
YPZ-1000W-940AZTFH-80DS(±8°)	D	—————→											
	N	—————→											
YPZ-3000W-2700DNFH-250DS(±8°) (+)2-YIL-1000FH-264DS(±8°)	D	—————→											
	N	—————→											
YPZ-3000W-2700AMTFH-6060-250DS(±8°) (+)2-YIL-1000FH-264DS(±8°)	D	—————→											
	N	—————→											
YIL-24FS-850S(±8°)	D	—————→											
	N	—————→											
YIL-56FS-850S(±8°)	D	—————→											
	N	—————→											
YIL-104FS-850S(±8°)	D	—————→											
	N	—————→											
YIL-1000FH-850S(±8°)	D	—————→											
	N	—————→											
YIL-5000FH-28SS(±5°)	D	—————→											
	N	—————→											
YCC-690RW-AZT-32HS(±8°)	D	—————→											
	N	—————→											
VCD-400-AZT-32HS(±8°)	D	—————→											
	N	—————→											
YCD-400-AZT-32HS(±8°)	D	—————→											
	N	—————→											
YCD-500-AZT-32HS(±8°)	D	—————→											
	N	—————→											
YCC-520RW-24FS(±8°)	D	—————→											
	N	—————→											
YCC-690RW-56FS(±8°)	D	—————→											
	N	—————→											
YCC-940RW-104FS(±8°)	D	—————→											
	N	—————→											
YCC-300RW-7DS(±15°)	D	—————→											
	N	—————→											

Wide angle illuminator”

“IR illuminator”

A	360° Endless or 350° Economic High Speed Pan/Tilt/64-Preset/8x8 Group Display with Long Range True Color Day/Night P/T/Zoom Camera (IP66, 20Kg), X-Y position data display on screen Intruders identification & motion tracking to use Defense of Borderline, Sea-side, airport, Seaport, DAM, Weapon area, Oil pumping area by Robot CCTV system
---	--



- Model List**
- 1) YPZ-5000WS-3000WAMTFH-101000/202000(+)-2-YIL-5000FH-28SS
: True color Day-30KM(90,000Ft)/Night-1KM(3,000Ft)
image pick-up
 - 2) YPZ-5000WS-3000WAMTFH-12750/251500(+)-2-YIL-5000FH-28SS
: True color Day-15KM(45,000Ft)/Night-1KM(3,000Ft)
image pick-up
 - 3) YPZ-5000WS-3000WAMTFH-10300(+)-2-YIL-5000FH-28SS:
: True color Day-5KM(15,000Ft)/Night-1KM(3,000Ft)
image pick-up
 - 4) YPZ-5000WS-3000WAMTFH-10200(+)-2-YIL-5000FH-28SS
: True color Day-2.5KM(7,500Ft)/Night-1KM(3,000Ft)
image pick-up
 - 5) YIL-5000FH-28SS
 - 28-Strong "IR" LED with collimator
 - Built-in DC-DC converter to use 9V-18V very wide operating range
 - Built-in cooling Fan & Heater to use -30°C~+55°C
 - Life time: 100,000HR (up to 10-years)
 - 850NM/10°, Visible "IR" : Up to 1KM by 2 PCS
 - 940NM/10°, Invisible "IR" : Up to 600M by 2 PCS

- ◎ Built-in 1/2" Sony EX-view or 1/3" sony double density color camera with D/N filter & DSS to take 0.00001 lux ultra sensitivity
- ◎ Built-in Laser "IR" illuminator (860NM) to use up to 1km clean image & 2km visible image pick-up at night (YLI-1000)
- ◎ 360° Endless or 350° Economic high speed heavy duty Pan/Tilt/64-Preset/8x8 Group display with X-Y position indicator to use long distance remote control by video server or GPS
- ◎ Day-30KM, 15KM, 5KM, 2.5KM/Night-Up to 1KM true color D/N camera by 1/2" EX-View or 1/3" sony double density color CCD with motorized D/N filter plus DSS (Digital Slow Shutter), (Day-0.01 lux/Night-0.00001 lux)
- ◎ Built-in 54-strong hybrid "IR" LEDs with collimator (+) Laser IR illuminator to take 2KM image pick-up at night
- ◎ Weather-proof metal case with wiper (IP66)
- ◎ AC24V~32V / DC24V~32V Wide operation
- ◎ Built-in RS-485/Pelco-D protocol RX. to use Max. 255-P/T/Zoom control by DVR, Joystick controller, "IR" remote - optional
- ※ Built-in MPEG-4/IP PTZ server to use DVD level real-time image display with P/T/Z control, Wiper on-off, Speaking, Alarm identification on screen by client PC (1,4,8,9,16CH. Multi-screen display software program by F.O.C)
- ※ Up to 2km clean image pick-up better than thermal camera by using Laser IR illuminator (960NM) at night

No	Model No.	Loading Camera	Loading Lens	Image pick-up
IP	YPZ-5000WS-3000WAMTFH-101000/202000	C/CS Mount D/N BOX 410K/540TVL True color D/N-0.00001 lux by DSS, D/N changing filter	10~1000mm (100x)/ 20~2000mm(2x extender) Motorized Zoom Auto iris lens with D/N filter	Up to 30km(90,000ft) at day
	(+)-2-YIL-5000FH-28SS	Life time: 100,000HR (up to 10-years)	850NM/10° or 940NM/10° -optional	Up to 1KM(3,000ft) at night
	YLI-1000	Laser "IR" illuminator (860NM)		Up to 2km(6,000Ft) clean at night
	YI0-200	20-I/O Port intruder identification with power supply (DC24V)x2 - P/S of PTZ & sensor		
	YPS-600	Dual 3-beam photoelectric sensor to use intruder identification with YI0-200		
IP	YPZ-5000WS-3000WAMTFH-12750/251500	C/CS Mount D/N BOX 410K/540TVL True color D/N-0.00001 lux by DSS, D/N changing filter	12.5~750mm(60x)/25- 1500mm by 2x Extender, Motorized Zoom Auto Iris Lens with D/N filter	Up to 15km(45,000ft) at day
	(+)-2-YIL-5000FH-28SS	Life time: 100,000HR (up to 10-years)	850NM/10° or 940NM/10° -optional	Up to 1KM(3,000ft) at night
	YLI-1000	Laser "IR" illuminator (860NM)		Up to 2km(6,000Ft) clean at night
	YI0-200	20-I/O Port intruder identification with power supply (DC24V) - P/S of PTZ & sensor		
	YPS-600	Dual 3-beam photoelectric sensor to use intruder identification with YI0-200		
IP	YPZ-5000WS-3000WAMTFH-10300	C/CS Mount D/N BOX 410K/540TVL True color D/N-0.00001 lux by DSS, D/N changing filter	10~300mm (30x) Motorized Zoom Auto Iris Lens with D/N filter	Up to 5KM(15,000Ft) at day
	(+)-2-YIL-5000FH-28SS	Life time: 100,000HR (up to 10-years)	850NM/10° or 940NM/10° -optional	Up to 1KM(3,000ft) at night
	YLI-1000	Laser "IR" illuminator (860NM)		Up to 2km(6,000Ft) clean at night
	YI0-200	20-I/O Port intruder identification with power supply (DC24V) - P/S of PTZ & sensor		
	YPS-600	Dual 3-beam photoelectric sensor to use intruder identification with YI0-200		

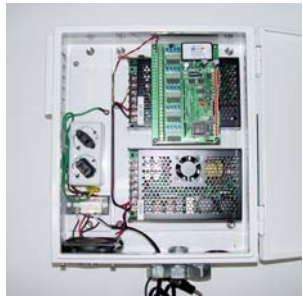
4	YPZ-5000WS-3000WAMTFH-10200	C/CS Mount D/N BOX 410K/540TVL True color D/N-0.00001 lux by DSS, D/N changing filter	10-200mm(20x) Motorized Zoom Auto iris lens with D/N filter	Up to 2.5KM(7,500Ft) at day
	(+)2-YIL-5000FH-28SS	Life time: 100,000HR (up to 10-years)	850NM/10° or 940NM/10° -optional	Up to 1KM(3,000ft) at night
	YLI-1KP	Up to 1km Human image pick-up by Laser IR illuminator at night (860NM)		Builtin Power level control circuits
	YLI-4KM	Up to 4km Human image pick-up by Laser IR illuminator at night (860NM)		Builtin motorized bean size control
	YI0-200	20-I/O Port intruder identification with power supply (DC24V) - P/S of PTZ & sensor		
	YPS-600	Dual 3-beam photoelectric sensor to use intruder identification with YI0-200		
5	YPS-600 Quad 3-beam photoelectric sensor to use intruder identification with alarm by dry contact relay	<ul style="list-style-type: none"> • Dual 3-beam Post for added range & reliability - up to 150M (Infra-Red Beam 6-lines) • Auto gain control to adjust for fog/rain/snow conditions • 4CH. IR beam selection to stop wrong detection • Filter circuits to spurious activation • DC12V-28V wide voltage operation • Weather-proof metal case with invisible IR beam cover to use outdoor (IP66) • Alarm output-Dry contact relay • DC12V-28V wide operation range • -40°C~+55°C by ceramic heater • Dimensions: 165x150x1,500 (WxDxH) / 6.49" x5.90" x59.05" • Good Price!!! 		
6	YI0-200 20-I/O Port to use intruder identification with P/S to use YPZ- 5000WS-series models	<ul style="list-style-type: none"> • 20-Port of intruder identification sensor from camera or Quad beam sensor(YPS-400) • Command to Robot camera (YPZ-5000WS-series models) move to intruder area automatically • Return to group operation at finished event from motion detection by cameras or Quad beam sensor at intruder identification. • DC24Vx2 Power supply to use PTZ & sensor together 		

B	350° Heavy Duty Slow Speed Pan/Tilt/Zoom/2-Strong "IR" illuminator (IP66, 30kg) Builtin "IP" Network P/T/Z cameras by using MPEG-4 A/V server / Stabilizer to use car, boat, strong wind area - optional
----------	--

※ Up to 2km clean image pick-up better than thermal camera by using 2-strong "IR" illuminator & Laser "IR" illuminator at night



© Builtin Laser "IR" illuminator (860NM) to use up to 1km clean image & 2km visible image pick-up at night (YLI-1000)

YPZ-3000W-3000WAMTFH-101000/202000, 12750/251500, 10300, 10200 +2-YIL-5000FH-28SS

- 350° Pan/Tilt/Motorized zoom day-night
- 1KM(3,000Ft) Image pick-up by 56-strong "IR" illuminator with collimator lens about 10.0 lux at night automatically

YIL-5000FH-28SS

- 28-Strong "IR" LED with collimator lens (850NM/±5°)
- Builtin DC-DC converter to use 9V~18V very wide operating range (AC24V/DC24V-optional)
- Builtin cooling Fan & Heater to use -30°C~+55°C
- Life time: 100,000HR (up to 10-years)
- 850NM/10°, Visible "IR": Up to 1KM by 2 PCS
- 940NM/10°, Invisible "IR": Up to 600M by 2 PCS

※ Builtin MPEG-4/IP PTZ server to use DVD level real-time image display with P/T/Z control, Wiper on-off, Speaking, Alarm identification on screen by client PC (1,4,8,9,16CH. Multi-screen Software display program by F.0.C)

No	Model No.	Loading Camera	Loading Lens	Image pick-up
----	-----------	----------------	--------------	---------------

1	YPZ-3000W-3000WAMTFH-101000/202000	C/CS Mount D/N BOX 410K/540TVL True color D/N-0.00001 lux by DSS, D/N changing filter	10-1000mm (100x)/ 20-2000mm (2x Extender), Motorized Zoom Auto Iris Lens with D/N filter	Up to 30km(90,000ft) at day
	(+)2-YIL-5000FH-28SS	Life time: 100,000HR (up to 10-years)	850NM/10 ° or 940NM/10 ° -optional	Up to 1KM(3,000ft) at night
	YLI-1000	Laser "IR" illuminator (860NM)		Up to 2km(6,000Ft) clean at night
2	YPZ-3000W-3000WAMTFH-12750/251500	C/CS Mount D/N BOX 410K/540TVL True color D/N-0.00001 lux by DSS, D/N changing filter	12.5-750mm (60x)/ 25-1500mm (2x Extender), Motorized Zoom Auto Iris Lens with D/N filter	Up to 15km(45,000ft) at day
	(+)2-YIL-5000FH-28SS	Life time: 100,000HR (up to 10-years)	850NM/10 ° or 940NM/10 ° -optional	Up to 1KM(3,000ft) at night
	YLI-1000	Laser "IR" illuminator (860NM)		Up to 2km(6,000Ft) clean at night
3	YPZ-3000W-3000WAMTFH-10300	C/CS Mount D/N BOX 410K/540TVL True color D/N-0.00001 lux by DSS, D/N changing filter	10-300mm(30x) Motorized Zoom Auto Iris Lens with D/N filter	Up to 5KM(15,000Ft) at day
	(+)2-YIL-5000FH-28SS	Life time: 100,000HR (up to 10-years)	850NM/10 ° or 940NM/10 ° -optional	Up to 1KM(3,000ft) at night
	YLI-1000	Laser "IR" illuminator (860NM)		Up to 2km(6,000Ft) clean at night
4	YPZ-3000W-3000WAMTFH-10200	C/CS Mount D/N BOX 410K/540TVL True color D/N-0.00001 lux by DSS, D/N changing filter	10-200mm(20x) Motorized Zoom Auto iris lens with D/N filter	Up to 2.5KM(7,500Ft) at day
	(+)2-YIL-5000FH-28SS	Life time: 100,000HR (up to 10-years)	850NM/10 ° or 940NM/10 ° -optional	Up to 1KM(3,000ft) at night
	YLI-1000	Laser "IR" illuminator (860NM)		Up to 2km(6,000Ft) clean at night
5	YPZ-3000W-3000WAMTFH-2700DNFH	X27 Auto zoom true color D/N-0.00001 lux by DSS & D/N filter	3.25-88mm (27x) Auto Zoom Lens	Up to 1.5KM(4,500Ft) at day
	(+)2-YIL-5000FH-28SS	Life time: 100,000HR (up to 10-years)	850NM/10 ° or 940NM/10 ° -optional	Up to 1KM(3,000ft) at night

C 350° Heavy Duty Slow Speed Pan/Tilt/Long Range Zoom Camera (IP66, 30kg)
 Builtin "IP" Network P/T/Z cameras by using MPEG-4 A/V server / Stabilizer to use car, boat, strong wind area – optional



YPZ-3000W-3000WAMTFH-101000/202000: 30KM (90,000Ft)

Up to 30KM(90,000Ft) true color D/N-0.00001 lux ultra sensitivity color camera by 1/2" Sony EX-View color CCD with motorized D/N filter, DSS plus Heavy duty P/T driver

YPZ-3000W-3000WAMTFH-12750/251500: 15KM (45,000Ft)

YPZ-3000W-3000AMTFH-10300 : 5KM(15,000Ft)

YPZ-3000W-3000WAMTFH-10200: 2.5KM(7,500Ft)

- Day-0.008lux true color/Night-0.000003lux B/W night vision Extreme CCTV Camera – optional
- Environmental metal housing with Wiper, Fan, Heater to use Dust, Sand, Rain area, Sea-side, On boat, Indoor/Outdoor (IP66, -30°C~+55°C)
- Builtin RS-485/Pelco-D RX. to use 255-P/T/Z multi-remote control of Pan/Tilt/Zoom/Focus/Auto Pan control by DVR, Controller, "IR" remocon

※ Builtin "IP" Network DVD level real-time image display with P/T/Z control, Wiper on-off, Speaking, Alarm identification on screen by client PC (Software program by F.O.C)

5	YPZ-3000W-3000WAMTFH-101000/202000	IP	No.9 with 350 ° heavy duty Pan/Tilt Machine(30kg) Builtin RS-485/Pelco-D RX, Builtin wiper
6	YPZ-3000W-3000WAMTFH-12750/251500	IP	No.10 with 350 ° heavy duty Pan/Tilt Machine(30kg) Builtin RS-485/Pelco-D RX, Builtin wiper
7	YPZ-3000W-3000WAMTFH-10300	IP	No.11 with 350 ° heavy duty Pan/Tilt Machine(30kg) Builtin RS-485/Pelco-D RX, Builtin wiper
8	YPZ-3000W-3000WAMTFH-10200	IP	No.12 with 350 ° heavy duty Pan/Tilt Machine (30kg) Builtin RS-485/Pelco-D RX, Builtin wiper

D Long Range Motorized Zoom Camera with Wiper (IP66)

- ⊙ Day-30KM, 15KM, 5KM, 2.5KM True color/Night- visible image B/W night vision by strong motorized zoom lens with 0.00001 lux D/N color camera (410K/540TVL)
- ⊙ Built-in RS-485/Pelco-D protocol to use MAX. 255-Zoom/Focus control by DVR, Joystick controller, IR remote control
- ⊙ Built-in "IP" Network P/T/Z cameras by using MPEG-4 A/V server - optional



- LVC-3000WAMTFH-101000/202000: 30KM image pick-up
- LVC-3000WAMTFH-12750/251500: 15KM image pick-up
- LVC-3000WAMTFH-23500 : 5KM image pick-up
- LVC-3000WAMTFH-10200 : 2.5KM image pick-up

- Day-0.008lux true color/Night-0.000003lux B/W night vision Extreme CCTV Camera - optional
- Environmental metal housing with Wiper, Fan, Heater to use dust, sand, rain area, sea-side, on boat, indoor/outdoor (IP66, -30°C ~ +55°C)
- Built-in RS485/Pelco-D RX. to use 255 Cameras multi-remote control of Zoom/Focus control by DVR, Controller, "IR" remote control
- Menu display & adjust of privacy mask, WDR, Motion detector, Flickerless, DSS, etc.

※ Built-in "IP" Network DVD level real-time image display with P/T/Z control, Wiper on-off, Speaking, Alarm identification on screen by client PC (Software program by F.O.C)

No	Model No	Loading Camera	Loading Lens	Image pick-up
9	LVC-3000WAMTFH-101000/202000 (DC12V/1.5A) Ⓜ Built-in wiper 1/2" Sony EX-View or 1/3" sony double density color CCD	C/CS Mount D/N BOX 410K/540TVL True color D/N- 0.00001 lux by DSS, D/N changing filter	10~1000mm(100x) / 20~2000mm by 2x Extender, Motorized Zoom Auto Iris Lens with D/N filter	Up to 30km(90,000ft)
10	LVC-3000WAMTFH-12750/251500 (DC12V/1.5A) Ⓜ Built-in wiper 1/2" Sony EX-View or 1/3" sony double density color CCD	C/CS Mount D/N BOX 410K/540TVL True color D/N- 0.00001 lux by DSS, D/N changing filter	12.5~750mm(60x) / 25~1500mm by 2x Extender, Motorized Zoom Auto Iris Lens with D/N filter	Up to 15km(45,000ft)
11	LVC-3000WAMTFH-10300 (DC12V/1.5A) Ⓜ Built-in wiper 1/2" Sony EX-View color CCD	C/CS Mount D/N BOX 410K/540TVL True color D/N- 0.00001 lux by DSS, D/N changing filter	10~300mm (30x) Motorized Zoom Auto Iris Lens with D/N filter	Up to 5KM(15,000Ft)
12	LVC-3000WAMTFH-10200 (DC12V/1.5A) Ⓜ Built-in wiper 1/2" Sony EX-View color CCD	C/CS Mount D/N BOX 410K/540TVL True color D/N- 0.00001 lux by DSS, D/N changing filter	10~200mm(20x) Motorized Zoom Auto iris lens with D/N filter	Up to 2.5KM(7,500Ft)

**E 350° Slow speed Heavy duty(30Kg) Pan/Tilt/Zoom Camera with Strong Hybrid "IR" Beam LEDs with collimator lens zoom Camera & Strong "IR" Beam illuminator together (IP66, DC12V)
Built-in 2-strong "IR" beam illuminator to take 1.5KM(4,500Ft) image pick-up at night
Built-in "IP" Network P/T/Z cameras by using MPEG-4 A/V server - optional**

※ DC12V operation to use Mobil vision, outdoor



- YPZ-3000W-2700DNFH-21SS+2-YIL-5000FH-28SS**
- 350° Pan/Tilt/2.25~88mm (27x) Auto zoom day-night
 - 1.2KM(4,000Ft) Image pick-up by 77-strong "IR" illuminator with collimator about 10.0 lux at night automatically
 - "IR" life time: 100,000hr (up to 10-years)

- YIL-5000FH-28SS**
- 28-Strong "IR" LED with collimator (850NM/±5° or 940NM/±5°-optional)
 - Built-in DC-DC converter to use 9V~18V very wide operating range
 - Built-in cooling Fan & Heater to use -30°C ~ +55°C
 - Life time: 100,000hr (up to 10-years)
 - 850NM/10°, Visible "IR": Up to 1.5KM by 2 PCS
 - 940NM/10°, Invisible "IR": Up to 800M by 2 PCS

※ Built-in "IP" Network DVD level real-time image display with P/T/Z control, Wiper on-off, Speaking, Alarm identification on screen by client PC (Software program by F.O.C)

1	YPZ-3000W-2700DNFH-21SS (+)-2-YIL-5000FH-28SS	No.2 with 2-strong "IR" illuminator with collimator lens 1.5KM(4,500Ft) image pick-up at night by 2-YIL-5000FH-28SS "IR" life time: 100,000HR (up to 10-years)
---	--	--

※ DC12V operation to use Mobil vision, outdoor



YPZ-3000W-2700DNFH-21SS 

- 350° Pan/Tilt/3.25~88mm(27x) Auto zoom day-night+DSS
- 300M(900Ft) Image pick-up by 21-strong "IR" illuminator with collimator lens about 10.0 lux at night automatically
- "IR" life time: 100,000HR (up to 10-years)
- 100% Weather-proof metal case to use outdoor (IP66)
- Builtin +15°C heating sensor & +35°C cooling fan sensor to safety operation (-30°C~+55°C)
- One power supply for Pan/tilt & zoom camera plus Strong IR illuminator with collimator lens together
- Builtin RS-485/Pelco-D RX to use 255-Pan/Tilt/ Zoom/Focus/Auto Pan Control by DVR, Controller, "IR" remocon (optional)
- Pan & Tilt angle adjust by limit sw.
- Day-true color/night-0.000 LUX B/W night vision by 27x optical zoom plus day-night motorized changing filter plus 21-strong "IR" illuminator with collimator (YPZ-3000W-2700DNFH-21SS)
- Image pick-up distance more than 300M(900Ft) by 2700DN and 400M(1,200Ft) by 2700AMTFH at night time.(850NM/±5°)
- 850NM/10°, Visible "IR": Up to 300M by 2 PCS
- 940NM/10°, Invisible "IR": Up to 200M by 2 PCS

※ Builtin "IP" Network DVD level real-time image display with P/T/Z control, Wiper on-off, Speaking, Alarm identification on screen by client PC (Software program by F.O.C)

2	YPZ-3000W-2700DNFH-21SS	No. 3 with 350 ° heavy duty(30kg) Pan/Tilt Machine Builtin RS-485/Pelco-D RX, "IR" Life time : 100,000HR (up to 10-years)
---	-------------------------	--



LVC-2700DNFH-21SS-AC: AC 90V~260V
LVC-2700DNFH-21SS-DC: DC9V~18V

※ Builtin 21 Strong "IR" LED with collimator lens- Life time: 100,000HR (up to 10-years)

※ AC24V/DC24V Operation - optional

- 850NM/10°: Up to 500M(1,500Ft) visible
Up to 1KM(3,000Ft) by two
- 850NM/25°: Up to 250M(750Ft) wide angle
- 940NM/10°: Up to 300M(900Ft) Invisible
- Family with 0.0001 lux D/N cameras
- AC24V/DC24V-optional

※ Builtin "IP" Network DVD level real-time image display with P/T/Z control, Wiper on-off, Speaking, Alarm identification on screen by client PC (Software program by F.O.C)

3	LVC-2700DNFH-21SS	3.25~88mm(27x) Auto Zoom D/N-0.0001 lux by DSS	21 pcs (DC12V/3A)	500M(1,500Ft) at night 1KM(3,000Ft) at two "IR" life time: 10-years	IP66 Indoor/ Outdoor
---	-------------------	--	-------------------	---	----------------------------

F	350° Medium duty(4kg) Pan/Tilt driver with Motorized Zoom Camera plus strong hybrid "IR" illuminator together Builtin RS-485/Pelco-D protocol RX. To use Max 255-P/T/Zoom control by DVR, Joystick controller, IR remocon (IP66, DC12V) Builtin "IP" Network P/T/Z cameras by using MPEG-4 A/V server - optional				
---	--	--	--	--	--

※ DC12V operation to use Mobil vision, Indoor/outdoor



YPZ-1000W-1000DNFH-7SS

- 340° Pan/Tilt/x27 Zoom Day-Night & x10 Digital Zoom
- 100M(300Ft) image pick-up by 7-strong "IR" LED with collimator at night automatically
- "IR" life time: 100,000HR (up to 10-years)
- 100% Weather-proof metal case with strong mechanism to use Mobil vision or outdoor (IP66)
- 0.0001 lux Star-light sensitivity by DSS (1000DNFH)
- Auto Pan is automatically stopped after operating for 10 min. to keep long life time.
- 850NM/10°, Visible "IR": Up to 100M by 2 PCS
- 940NM/10°, Invisible "IR": Up to 60M by 2 PCS

※ Builtin "IP" Network DVD level real-time image display with P/T/Z control, Wiper on-off, Speaking, Alarm identification on screen by client PC (Software program by F.O.C)

1	YPZ-1000W-1000DNFH-7SS	No. 2 with 340° medium duty(4kg) Pan/Tilt Machine Builtin RS-485/Pelco-D RX, "IR" Life time : 100,000HR (up to 10-years)
---	------------------------	---

Strong hybrid "IR" Module with collimator lens with Zoom Camera to take Long distance image pick-up at night (850NM, ±5°), Builtin Metal case with Sun shield (IP66)



MODEL: LVC-1000DNFH-7SS (x27 Auto Zoom D/N)

- 3.25~88mm(27x) Auto zoom with D/N filter to take Day-true color/Night-0.0001 lux B/W Night Vision Color Camera by DSS (Digital Slow Shutter)
- Builtin 7-strong "IR" LED with collimator lens to take 100M(300Ft) image pick-up at night
- Builtin +15°C heating sensor & +35°C cooling fan sensor to safety operation (-30°C~+55°C)
- "IR" Life time: 100,000HR (up to 10-years)
- AC24V/DC24V operation - optional
- 850NM/10°, Visible "IR": Up to 100M by 2 PCS
- 940NM/10°, Invisible "IR": Up to 60M by 2 PCS

No	Model No	Loading Camera	Strong "IR" LED with collimator	Image pick-up	Case conditions
2	LVC-1000DNFH-7SS	3.25~88mm(27x) Auto Zoom D/N-0.0001 lux by DSS	7 pcs (DC12V/1.2A)	100M(300Ft) at night 100M(300Ft) at day	IP66 Indoor/Outdoor

G 350° Stainless steel housing with wiper, Cleaning pump & tank, heavy duty Pan/Tilt driver (20kg) to use sea-side, on boat, dust or rain area, Oil plant, Chemical plant, etc. (IP66, -30°C~+55°C)
"IP" Network P/T/Z cameras by using MPEG-4 server - optional

- ◎ Builtin 3.25~88mm(x27) Auto Zoom D/N-0.0001 lux Star-light sensitivity color camera or 6~60mm or 10~200mm Motorized Zoom D/N-0.00001 lux ultra sensitivity color camera by 1/3" Sony double density color CCD Camera with D/N-changing filter & DSS (optional)
- ◎ Menu display & adjust of privacy mask, WDR, Motion detector, Flickerless, DSS, etc.
- ◎ Builtin Strong "IR" LED with special collimator lens to take 300M(900Ft) image pick-up about 10.0 lux at night automatically, Life time: 100,000HR (up to 10-years)
- ◎ Builtin RS-485/Pelco-D RX to use 255-Cameras Multi-Remote control of Pan/Tilt/Zoom/ Focus/Menu control by DVR, Controller, Remocon

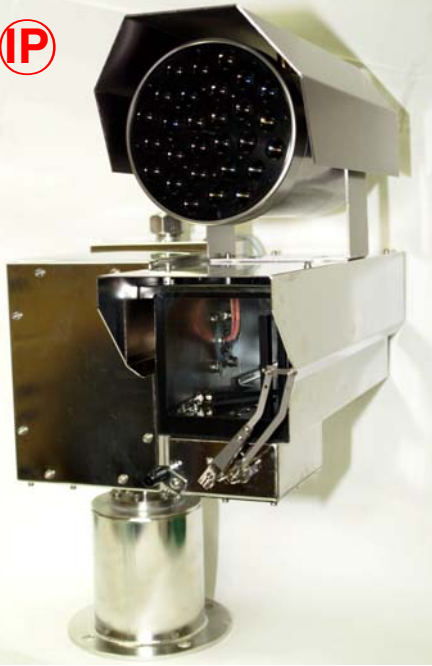

YPZ-7000WFH-2700DN : Pan/Tilt/x27 Zoom
YPZ-7000WFH-2700DN+YIL-5000FH-28SS
YPZ-7000WFH-2700AMT-6060/10200+YIL-5000FH-28SS

- ※ Built-in RS-485/Pelco-D RX. To use 255-Pan/ Tilt/Zoom/Focus/Auto pan control by DVR, Controller, "IR" remote control
- ※ Cooling Fan & Heater to use -30°C~+55°C
- ※ Built-in wiper, wash pump & tank to use sea side, on boat, chemical plant
- ※ Built-in stainless steel housing with rubber seal to use worst outdoor area (IP66)
- ※ Built-in strong "IR" illuminator with collimator to take 300M(900Ft) image pick-up at night - YIL-5000FH-28SS
Life time: 100,000HR (up to 10-years)
- ※ 0.0001 lux Star-light sensitivity by using digital slow shutter (DSS) - 2700DN
- ※ Image pick-up 300M(900Ft) by 2700DN or 2700AMT by using YIL-5000FH-28SS.
- ※ Total Power consumption: DC12V/5A (60W)
- ※ Auto Pan is automatically stopped after operating for 10 min. to keep long life time.
- ※ Built-in Menu display of privacy mask, WDR, Motion detector, Flickerless, etc.-2700AMT
 - 850NM/10°, Visible or 940NM/10°, Invisible - optional

※ Built-in "IP" Network DVD level real-time image display with P/T/Z control, Wiper on-off, Speaking, Alarm identification on screen by client PC (Software program by F.O.C)

No	Model No	Application	Image pick-up	Power
1	YPZ-7000WFHS-2700DN (3.25-88mm Auto zoom D/N)	Built-in Wiper, Fan, Heater, Wash pump & tank to use Dust area, On Boat, Sea-side, Chemical plant	1KM(3,000Ft)	DC12V/5A
2	YPZ-7000WFHS-6060	Same above with 6~60mm(10x) Motorized zoom D/N-0.00001 lux by 1/3" Sony double density color CCD with D/N filter, DSS	1KM(3,000Ft)	DC12V/5A
3	YPZ-7000WFHS-10200	Same above with 10~200mm(20x) telephoto Motorized Zoom D/N-0.00001 lux by 1/3" Sony double density color CCD with D/N filter, DSS	2.5KM(7,500Ft)	DC12V/5A
4	YPZ-7000WFHS-2700DN (+)YIL-5000FH-28SS	No.1 with strong "IR" illuminator with collimator lens "IR" life time: 100,000HR (up to 10 years)	300M(900Ft)- image pick-up at night	DC12V/8A
5	YPZ-7000WFHS-6060 (+)YIL-5000FH-28SS	No.2 with strong "IR" illuminator with collimator lens "IR" life time: 100,000HR (up to 10 years)	300M(900Ft)- image pick-up at night	DC12V/8A
6	YPZ-7000WFHS-10200 (+)YIL-5000FH-28SS	No.3 with strong "IR" illuminator with collimator lens "IR" life time: 100,000HR (up to 10 years)	300M(900Ft)- image pick-up at night	DC12V/8A

H	<ul style="list-style-type: none"> ◎ 350° Explosion-proof stainless steel case heavy duty Pan/Tilt/Zoom/Focus Multi-remote control color camera by DVR, Controller, Remote control. (IP66, -30°C~+55°C) ◎ Built-in RS-485/Pelco-D protocol RX to use 255-P/T/Z/F control by DVR, Joystick controller, Remote control ◎ Built-in Strong "IR" LED with special collimator lens to take 300M(900Ft) image pick-up about 10.0 lux at night automatically, Life time: 100,000HR (up to 10-years) ◎ "IP" Network P/T/Z cameras by using MPEG-4 A/V server - optional
---	--

※ DC12V operation to use dangerous area



YPZ-9000WFH-2700DN-28SS

- 350° Pan/Tilt/x27 Zoom day-night+DSS
- 300M(900Ft) Image pick-up by 28-strong "IR" illuminator with collimator about 10.0 lux at night automatically, "IR" life time: up to 10-years

YPZ-9000WFH-2700AMT-6060/10200-28SS

- 350° Pan/Tilt/6~60mm or 10~200mm Motorized zoom day-night
- 300M(900Ft) Image pick-up by 28-strong "IR" illuminator with collimator about 10.0 lux at night automatically, "IR" life time: up to 10-years
- Day-0.05 lux true color/night-0.00001 lux ultra sensitivity BY 1/3" sony double density color CCD with day-night motorized changing filter & DSS about 10.0 lux automatically (2700AMT-6060/12240)

YPZ-9000WFH-RS485/Pelco-D

- 350° Explosion-proof heavy duty stainless steel case Pan/Tilt machine to use dangerous area such as chemical plant, oil plant, weapon plant, boat of gas tanker
- Builtin Cooling fan & Heater to use worst outdoor (-30°C~+55°C)

YIL-5000FH-28SS

- 28-Strong "IR" LED with collimator (850NM/±5°)
- Builtin DC-DC converter to use 9V~18V very wide operating range
- Builtin cooling Fan & Heater to use -30°C~+55°C
- DC12V/3A (36W)
- Life time: 100,000HR (up to 10-years)
- 850NM/10°, Visible or 940NM/10°, Invisible - optional

※ Builtin "IP" Network DVD level real-time image display with P/T/Z control, Wiper on-off, Speaking, Alarm identification on screen by client PC (Software program by F.O.C)

No	Model No	Application	Image pick-up	Power
1	YPZ-9000WFH-2700DN (3.25~88mm Auto zoom D/N - 0.0001 Lux by DSS)	Dangerous area such as Weapon plant, Chemical plant, Oil plant, Gas tanker boat	1KM(3,000Ft) at day	DC12V/3A (84W)
2	YPZ-9000WFH-6060	Same above with 10~60mm(10x) Motorized Zoom D/N-0.00001 lux ultra sensitivity color camera by DSS & D/N filter	1KM(3,000Ft) at day	DC12V/3A (84W)
3	YPZ-9000WFH-10200	Same above with 10~200mm(20x) Motorized Zoom D/N-0.00001 lux ultra sensitivity color camera by DSS & D/N filter	2.5KM(7,500Ft) at day	DC12V/3A (84W)
4	YPZ-9000WFH-2700DN-28SS (Builtin YIL-5000FH-28SS)	No.1 with strong "IR" illuminator with collimator lens 300M(900Ft) image pick-up at night by YIL-5000FH-28SS "IR" life time: 100,000HR (up to 10 years)		
5	YPZ-9000WFH-6060DN-28SS (Builtin YIL-5000FH-28SS)	No.2 with strong "IR" illuminator with collimator lens 300M(900Ft) image pick-up at night by YIL-5000FH-28SS "IR" life time: 100,000HR (up to 10 years)		
6	YPZ-9000WFH-10200DN-28SS (Builtin YIL-5000FH-28SS)	No.3 with strong "IR" illuminator with collimator lens 300M(900Ft) image pick-up at night by YIL-5000FH-28SS "IR" life time: 100,000HR (up to 10 years)		

I Wide angle strong "IR" beam illuminator with motorized Zoom True Color D/N-100M, 200M, 300M, 500M image pick-up Color Camera plus 350° heavy duty Pan/Tilt driver (±8°, IP66, DC12V) Builtin RS-485/Pelco-D RX. To use 255-P/T/Z/F control by DVR, Joystick controller, "IR" Remocon "IP" Network P/T/Z cameras by using MPEG-4 A/V server - optional



※ Built-in "IP" Network DVD level real-time image display with P/T/Z control, Wiper on-off, Speaking, Alarm identification on screen by client PC (Up to US\$2500) - Software program by F.O.C

No	Model No.	Camera	IR LEDs P/T	P/T	Image pick-up
1	YPZ-1000W-940DNFH-94DS (410K/480TVL) (IP)	3.25~88mm(27X) Auto Zoom D/N	850NM±8° 94 PCS	YPZ-1000W (4kg)	Day-1KM (3,000Ft) Night-50M (150Ft)
2	YPZ-1000W-940AZTFH-80DS (410K/540TVL) (IP)	5~50mm Vari-focal Auto IRIS D/N	850NM±8° 80 PCS	YPZ-1000W (4kg)	Day-500M (1,500Ft) Night-100M (300Ft)
3	YPZ-3000W-2700DNFH-250DS (410K/480TVL) (IP)	3.25~88mm (27x) Auto Zoom D/N	850NM±8° 228 PCS	YPZ-3000W (30kg)	Day-1KM (3,000Ft) Night-100M (300Ft)
4	YPZ-3000W-2700DNFH-250DS(+)-2-YIL-10000FH-264DS (410K/480TVL) (IP)	3.25~88mm (27x) Auto Zoom D/N	850NM±8° 756 PCS	YPZ-3000W (30kg)	Day-1KM (3,000Ft) Night-500M (1,500Ft)

J Heavy duty Pan/Tilt driver with RS-485/Pelco-D protocol RX. (IP66, -30°C~+55°C)
"IP" Network P/T/Z cameras by using MPEG-4 A/V server - optional



※ Built-in MPEG-4/IP PTZ server to use DVD level real-time image display with P/T/Z control, Wiper on-off, Speaking, Alarm identification on screen by client PC (Up to US\$250.00) - 1,4,8,9,16CH. Multi-screen display Software program by F.O.C

No	Model No	Multi-Control	Loading Capacity.	Available Loading Camera	Case conditions
1	YPZ-1000W (IP) RS-485/Pelco-D	340° Pan/Tilt//Auto Pan control by DVR, Controller, Remocon	MAX. 4kgs (DC12V/0.4A)	All Camera & illuminator acceptable	IP66, Mobil vision Indoor/Outdoor
2	YPZ-3000W (IP) RS-485/Pelco-D	350° Pan/Tilt/Auto Pan control by DVR, Controller, Remocon	MAX. 30kgs (DC12V/0.8A)	All Camera & illuminator acceptable	IP66, Mobil vision Indoor/Outdoor
3	YPZ-5000WS (IP) RS-485/Pelco-D	360° Endless or 350° Economic high speed Pan/Tilt & 64-Preset/8x8 Group display by stepping motor	MAX. 20kgs Pan/15W Tilt/6W AC24V or DC24V	All Camera & illuminator acceptable	IP66, Mobil vision Indoor/Outdoor

K Built-in 28-Hybrid Module Strong "IR" LEDs with collimator lens "IR" beam illuminator to use up to 500M(1,500Ft) image pick-up about 10.0 lux at night automatically (±5°, DC12V, AC24V/DC24V-optional, IP66)



YIL-5000FH-28SS-AC: AC FREE
YIL-5000FH-28SS-DC: DC12V/3.0A(36W)

- Weather-proof Metal case to use Indoor/Outdoor (IP66)
- Included sun shield, Mounting bracket
- DC12V operation to use Outdoor
- AC24V or DC24V – optional
- ◎ 850NM/10°: Up to 500M(1,500Ft) visible
Up to 1KM(3,000Ft) by two
- ◎ 850NM/25°: Up to 250M(750Ft) wide angle
- ◎ 940NM/10°: Up to 300M(900Ft) Invisible
- ◎ Family with 0.0001 lux D/N cameras
- ◎ AC24V/DC24V–optional

No	Model No	Strong "IR" LED with collimator	Combination Camera	Image pick-up at night	Case conditions
1	YIL-5000FH-28SS	28 pcs (DC12V/3A)	0.00001 lux ultra sensitivity camera	500M(1,500Ft) by one 1KM(3,000Ft) by two	IP66 Indoor/Outdoor
K1	Built-in 7-Hybrid Module Strong "IR" LEDs with collimator lens "IR" beam illuminator to use up to 100M(300Ft) image pick-up about 10.0 lux at night automatically, 850NM or 950NM – optional Small & strong case (IP66)				
No	Model No	Strong "IR" LED with collimator	Combination Camera	Image pick-up at night	Case conditions
1	YIL-1000FH-7SS	7 pcs (DC12V/1.0A)	0.00001 lux ultra sensitivity camera	100M(300Ft) by one 200M(600Ft) by two	IP66 Indoor/Outdoor

YLI-1000, Strong Laser IR illuminator (860NM)

Feature

- ▶ Typical wavelength, 860nm
- ▶ Stabilized optical power 890mW
- ▶ Single supply voltage, 12V DC
- ▶ APC control
- ▶ Adjustable Beam size
- ▶ 4Pin connector(standard) or custom
- ▶ Active temperature control (TE Cooler & Internal Fan)
- ◎ Option : Bracket & Power supply.

Description

The YLI-1000 series laser diode module combines laser diode technology, quality optics and sophisticated electronics for **laser light** instead of normal light. This series of modules provides infrared(860nm) laser beam.

※ Up to 1 Km(3,000Ft) clean image & 2km visible image by 0.0001 lux B/W Camera at night

Specification



• Optical

Optical power(mW)	890 (Tc=25°C)
LD power(mW)	1000 (Max)
Output Efficiency(%)	89
Wavelength(nm)	860 ±10
Beam Dia(m)	1.2x0.9 (at 10M)
Beam Div(degree) *half	3.43 x 2.58
LD Pin Connection	Case Positive



L Wide angle strong "IR" beam illuminator, up to 200M(600Ft), 50M(150Ft), 30M(90Ft), 20M(60Ft), 10M(30Ft) image pick-up at night automatically
 Built-in Big Q'ty super "IR" LEDs with wide angle (850NM±8°)

No	Model No	Leds	Image pick-up	Installation
1	YIL-24DS-950	24-950NM	10M-visible	Indoor/Outdoor
2	YIL-24DS-850	24-850NM	10M-clean	Indoor/Outdoor
3	YIL-24FS-850S	24-850NM	20M-clean	Indoor/Outdoor
4	YIL-56DS-950	56-950NM	20M-visible	Indoor/Outdoor
5	YIL-56DS-850	56-850NM	20M-clean	Indoor/Outdoor
6	YIL-56FS-850S	56-850NM	30M-clean	Indoor/Outdoor
7	YIL-104DS-950	104-950NM	30M-visible	Indoor/Outdoor
8	YIL-104DS-850	104-850NM	30M-clean	Indoor/Outdoor
9	YIL-104FS-850S	104-850NM	50M-Clean	Indoor/Outdoor
10	YIL-1000FH-264DS	264-850NM Strong	200M-Clean	Indoor/Outdoor

※Remarks: Image pick-up distance acceptable by x27 Zoom day-night cameras, Vari-focal zoom day-night cameras, Fixed lens day-night cameras by using D/N filter & 1/3" EX-VIEW Color CCD Cameras

M 360° Rotating High speed dome Pan/Tilt/x27 Zoom day-night camera (3.25~88mm)
340° Rotating speed dome Pan/Tilt/x27 Zoom day-night camera (3.25~88mm)
5"Vandal & Weather-proof dome to use indoor/outdoor (IP66)Builtin RS-485/Pelco-D & P protocol
to use 255-P/T/Z cameras multi-remote control by DVR, computer, remocon (optional), Flush or
Surface mount both available
Builtin "IP" Network P/T/Z cameras by using MPEG-4 A/V server – optional



※ Builtin "IP" Network DVD level real-time image display with P/T/Z control, Wiper on-off, Speaking, Alarm identification on screen by client PC (Software program by F.O.C)

No	Model no.	Camera	RS-485	Sensitivity	Installation	Remarks
1	YPZ-2000WS-3120DN "Full Functions" "High Speed" "Image stabilizer"	3.5-91mm x26 Zoom with x12 Digital Zoom DC12V/3.3W	Yes Pelco- D, P	Day-true color Night-0.001 lux by D/N filter & B/W image	Outdoor, Indoor, Car, Bus	Builtin image stabilizer to save vibration image for Mobile vision, Military area, Fire Engine, Battle Tank, UAV, Speed Boat, etc.
	WTX-2000S	Miniature joystick controller - Family with YPZ-2000WS-2700DN				
2	YPZ-500SDN-220x "Full functions" "High speed"	X22 Zoom day- night X10 Digital zoom Mobil installation	Yes, Pelco- D, P	Day-true Color/ Night-0.001 lux B/W night vision	Indoor Outdoor	360°-Speed dome P/T/Z 64-Preset & Pattern, Tour, Group display function DC12V/1.0A
3	YPZ-400SDN-4090 "Full functions" "High Speed"	4-9mm Vari-focal Auto iris & D/N filter 410K/540TVL	Yes, Pelco- D, P	Day-true color/ Night-0.001 lux B/W night vision	Indoor Outdoor	360°-Speed dome P/T/4-9 Vari-focal Zoom Auto iris, D/N filter 64-Preset & Pattern, Tour DC12V/0.7A
4	YPZ-500DN-270x/220x "Pan/Tilt/Zoom/Focus" "High Speed"	X27 or x22 Zoom day-night X10 Digital zoom	Yes Pelco- D	Day-true color/ Night-0.01 lux B/W night vision	Indoor Outdoor	340°-Speed dome P/T/Z Economic price DC12V/500mA
5	YPZ-800M/MBH-2700DN Builtin Blower & heater	X27 Zoom day- night X10 Digital zoom	Yes Pelco- D	Day-true color/Night-0.01 lux B/W night vision	Indoor Outdoor	8" Metal dome 340° Slow speed Pan/Tilt/Zoom/Focus/Menu/Auto pan control, DC12V/1.0 AMP.

6	YPZ-1500M/MBH-2700DN AC24V/1.0AMP.	X27 Zoom day-night X10 Digital zoom	Yes Pelco-D	Day-true color/Night-0.01 lux B/W night vision	Indoor Outdoor	10" Vandal & Weather-proof dome 340° Slow speed Pan/Tilt/Zoom Builtin blower heater(MBH)
						
7	YMDR-100m	Handy type Miniature MJPEG DVR	1CH./Composite Video SD Memory changeable 15FPS/1.7HR, 10FPS/2.5HR, 5FPS/5.2HR, 2FPS/13HR, 1FPS/26HR	Application area: SPY shop Mobil vision Family with YPZ-2000WS-2700DNFH-IP		
8	HMB-50K "Family with YPZ-2000WS-2700DNFH-IP"	Rugged Notebook PC	MIL-STD-800 Series approved Water-proof notebook PC to use vibration area or outdoor such as Mobile, Military Zone, etc.	Main Partners: US Army/Navy, USMC, NATO, General Dynamics L-3 Communications, Raytheon USA.		
Family with YPZ-2000WS-2700DN-IP/3120DN-IP to use outdoor & mobile vision						

N 5" Outdoor housing 360° Endless Speed Dome Pan/Tilt/x22 Zoom D/N-0.001 lux B/W night vision color camera, RS-485/Pelco-D, P (IP66, -30°C~+55°C)

0.0001 LUX Star-light sensitivity by digital slow shutter (DSS)

Builtin cooling Fan, Heater to use indoor/outdoor (-30°C~+55°C)

64-Preset & 8-Swing, Group display, Alarm In/Out (2/2) support.

※ Builtin "IP" Network DVD level real-time image display with P/T/Z control, Wiper on-off, Speaking, Alarm identification on screen by client PC (Software program by F.O.C) - **YOH-500SDN-400PTZ**



YOH-500SDN-220x, YOH-500SDN-220x-IP

1. Fast & Silent Motion

- * Lightning Speed : MAX. 220°/sec
- * Smooth Manual Speed : MIN. 0.05°/sec
- * Endless 360° Pan Rotation
- * Lowest Noise & Lowest Vibration
- * Shortest Path by Vector Drive Technology
- * High Accuracy with Micro-Stepping

2. Superior Zoom Camera

- * X220 Zoom Control (Optical X22, Digital X10)
- * Day & Night by electronic circuits

3. Powerful Functions

- * 64 Preset Positions with Alphanumeric Labels
- * Pattern, Swing and Group Functions
- * Alarm In/Out (2 In / 2 Out) Support
- * Small Size (ø114-230mm)
- * IP 66 Weather proof and Built-in Fan & Heater

4. Builtin IP PTZ/MPEG-4 server to use 480TVL image display with PTZ control, Motion detection with alarm on-off, Record & play back by Web-hard by client PC.

(Plug-in & Play 16CH. Software program by F.O.C)

O Economic Type Pan/Tilt/Zoom or Vari-focal Zoom cameras-DC12V operation
 Builtin RS-485/Pelco-D to use 255-P/T/Z cameras multi-remote control of Pan/Tilt/Zoom/
 Focus/Menu/Auto pan on-off by DVR, Pelco-D controller"IR"remocon (optional) Internet CCTV
 system to use Traffic, Office, Home image observation with P/T/Z control by client PC or DVR by
 using Network video server(NVS-100PTZ) - optional
 Builtin "IP" Network P/T/Z cameras by using MPEG-4 A/V server - optional



※ Builtin “IP” Network DVD level real-time image display with P/T/Z control, Wiper on-off, Speaking, Alarm identification on screen by client PC (Software program by F.O.C)

No	Model no	Dome	Camera	Sensitivity	Installation	Remarks
1	YPZ-100-C/D	4" Vandal Dome 410K/480TVL	1/3" Sony Super-had X3 Digital zoom	0.1 Lux normal 0.01 Lux IR	Indoor/Outdoor RS-485/P-D	4" Vandal dome to use Indoor/Outdoor Builtin RS-485/P-D MPEG4 A/V server
2	YPT-100-AZT 4" Dome	4" Dome Day-night filter	1/3" Sony ex- view ccd	Day-true color/ night-0.0001 lux	Indoor only RS-485/P-D	Miniature speed dome Builtin RS-485/Pelco-D protocol
3	YPT-100-C/D 4" Dome	4" Dome 410K, 480TVL	1/3" Sony Super-had X3 Digital zoom	0.1 Lux normal 0.01 Lux IR	Indoor only RS-485/P-D	Miniature speed dome Builtin RS-485/Pelco-D protocol
4	GAC-PT1	Pan/Tilt only	None	None	Indoor	Heavy duty-max. Loading 4kgs.
5	GAC-PT1+RS-485	Pan/Tilt only	None	None	Indoor	Same above, Pelco-D
6	GAC-PT1+LVC-2701DN RS-485/Pelco-D	None Day-night filter	X27 Zoom day- night	Day-true color/ night-0.01 lux	Indoor only	Pan/Tilt/x27 Zoom day-night
7	YPZ-800+2700DN	8" Dome Day-night filter	X27 Zoom day- night	Day-true color/ night-0.01 lux	Indoor Outdoor	8" Weather-proof dome to use indoor/outdoor

P 3.25~88mm(x27) Auto Zoom Day-true color/Night-0.0001 lux B/W night vision color camera with D/N filter & DSS. (Builtin RS485/Pelco-D Protocol RX.)

◎ X27 Optical zoom with X216 digital zoom & digital motion detector, available digital slow shutter (DSS) to take 0.0001 lux star-light sensitivity

◎ Builtin RS-485/Pelco-D to use 255-Zoom cameras multi-remote control of Zoom/Focus/Menu/Digital-Pan/Tilt/Auto pan by DVR, Pelco-D controller, “IR”remocon (optional)

※ Builtin “IP” Network DVD level real-time image display with P/T/Z control, Wiper on-off, Speaking, Alarm identification on screen by client PC (Software program by F.O.C)

No	Model no	Lens	CCD sensor	Sensitivity	Installation	
1	LVC-2700DN- 27x/216x with DSS	X27 Optical zoom day- night	1/4" IT ccd 410K, 480TVL	Day-true color/ Night-0.01 lux Night-0.0001 lux	Indoor only optional cable assy-20M(60Ft), 30M(90Ft), 100M(300Ft)	
2	LVC-3000HDN- 27x/216x with DSS	X27 Optical zoom day- night	1/4" IT ccd 410K, 480TVL	Day-true color/ Night-0.01 lux Night-0.0001 lux	Indoor/Outdoor 100% weather- proof metal	
3	VCD-500DN- 270x 5" Vandal dome with DSS 	X27 Zoom Day-night	1/4" IT Sony super-had	Day-true color Night-0.01 lux B/W Night-0.0001 lux	Indoor/Outdoor Flush mount or Surface mount both available RS-485/Pelco-D	

Q MAX. 255 PCS–Pan/Tilt/Zoom Cameras–central remote controller to use Pan/Tilt/Zoom/Tour/ Group/ Pattern display by using RS–485/Pelco–D, P protocol TX.
Wireless remote control of speed dome or slow dome by IRC–200 or IRC–100



No	Model no	Descriptions	Acceptable model
1	PTZ-1000	2-Axis Joy-stic to use speed Pan/Tilt & zoom control by RS-485/Pelco-D or P & others, DC12V/450mA	YPZ-500SDN, YPZ-500DN, YPZ-800M, YPZ-1500M & other speed dome Pan/Tilt/Zoom cameras
2	PTZ-2000	3-Axis Joy-stick to use speed Pan/Tilt/Zoom-in/Zoom-out control by RS-485/Pelco-D or P & others, DC12V/450mA	
3	IRC-200	Wireless remote control by "IR" remocon by using "IR" to RS-485 converter, same control function of PTZ-1000 or PTZ-2000	Same above
4	IRC-100	Wireless remote control by "IR" remocon by using "IR" to RS-485 converter, RS-485/Pelco-D protocol	YPZ-500DN, YPZ-800M, YPZ-1500M/MBH, YPT-100 Series models

R MPEG-4/Standalone DVR – 4CH. 9CH. 16CH. , Built-in DDNS Network Video server
MJPEG/Standalone DVR – Mobile vision, standalone, Built-in DDNS Network Video server

※ Family with Network Video Server (T)

① ② ③



- * Mobile DVR
- * 1CH Audio
- * 4CH Video
- * Shake Prevention

④



No	Model No	Description	Remarks
1	YMDR-1620	16CH. MPEG-4, Front Loading HDD, Real time with Audio, Built-in DDNS Network server	HDD-optional
2	YMDR-920	9CH. MPEG-4, Front Loading HDD, Real time with Audio, Built-in DDNS Network server	HDD-optional
3	YMDR-420	4CH. MPEG-4, Front Loading HDD, Real time with Audio, Built-in DDNS Network server	HDD-optional
4	YMD-104W	4CH. MJPEG, Mobil vision, shake prevention, DC10V-28V operation	HDD-optional
5	YDR-401	4CH. MJPEG, Standalone, Economic	HDD-optional
	YDR-401/WEB	Built-in DDNS Network server	

S1 Network Video Server –All Cameras change to "IP" Network CCTV system & Decoder

Miniature Network video server to use Internet CCTV observation with P/T/Z control all cameras acceptable

1	NVS-400PTZ	MPEG-4 Real time A/V server: DVD level image display with PTZ control, Wiper on-off, x2 extension, 2-way audio, alarm identification by client PC
2	NVS-400PTZ-4	Same above with 4CH. with QUAD output
3	DVS-400PTZ-4	4CH. Standalone decoder with WEB-HARD control function Digital signal decode to Analog signal to display composite monitor & joystick PTZ control, Wiper on-off, x2 extension, etc



Model	Cedar860AG 5158-P18		
Frequency	IEEE802.11abg, 2.4GHz/5GHz Dual Band	Bridging/VLAN	IEEE802.1d Spanning Tree 802.Q VLAN ids 2048 MAC Address Filter SSID to VPN mapping Hidden broadcasting SSID for each WLAN RTS/CTS threshold setting Selectable Beacon with BSSID Power control for Bridge link
5GHz band width	5.150 ~ 5.250GHz, 5.250 ~ 5.350GHz 5.500 ~ 5.700GHz, 5.725 ~ 5.825GHz		
2.4GHz band width	2.400 ~ 2.484GHz		
Wireless speed	54/48/36/24/18/12/9/6Mbps		
Ethernet port	1Port 10/100Base-T (802.3af PoE)	Authentication	Pre-Shared Key Authentication MAC Address integrated management 802.1x Radius : EAP-PEAP, EAP-TLS, EAP-TTLS Radius Authentication with user account base 802.1x Authentication Primary and Secondary Radius Server Failover Dynamic VLAN assignment WPA, TKIP, WPA2, 802.11i(AES , CCMP) Rouge AP detection
antenna	Built-in 5GHz 18dBi patch		
optional antenna p	N-type Female connector		
Wireless Power	802.11a : 18dBm (60mW) 802.11g : 18dBm (60mW) 802.11B : 20dBm (100mW)		
Wireless power	Auto control		
Wireless channel	Auto control		
Management	Using intelicis Cypress 1024 or Cypress 1008	Network management	WEB Based management (HTTP, HTTPS) WEB Based GUI CLI management through Telnet SNMP V2c, MIB II, Intelicis MIB, SNMP Traps NAT System Event Log Connection level Multi-management FTP, TFTP upgrade Flash Image recovery System Even Log
Multiple SSID	31 multiple SSID		
Operation Mode	3 type mode - AP Mode - Bridge Mode - AP with Bridge Mode		
Protocol	802.3 Protocol (Ethernet) Static IP or DHCP Client IP Address filter WMM Multiple Class QoS Primary & Secondary DNS		
		Size/Weight	Size : 345(W)x372(H)x63.5(D)mm, Weight 2.680.4kg
		Temperature	Operation : -30 ~ 60°C, Storage : -40 ~ 70°C
		Humidity	10 ~ 95%, Numidity : 10 ~ 95% non-condensing

T New generation 540TV Lines Super Resolution True color D/N-0.0001 lux B/W night vision color cameras

- ◎ 1/3" Sony EX-View HQ color CCD to make 410K pixels/540TV Lines Super resolution Day-0.05 lux true color/Night-0.0001 lux B/W ultra sensitivity New generation color cameras
- ◎ Built in Very strong "IR" illuminator to take long distance image pick-up 30M(90Ft), 50M(150Ft), 100M(300Ft), 200M(600Ft) about 10.0 lux at night automatically, Built in Cooling Fan Motor.
- ◎ DC12V operation to use safety installation Indoor/Outdoor (IP66)

T1, Bullet Metal case with Sun Shield to use Indoor/Outdoor (IP66)



No	Model No	Sensitivity (LUX)	Lens(mm)	Strong" IR" LEDs (850S)	Image pick-up at night
1	YCC-690RW-AZTHQ-4/9	D-True color(0.05) N-B/W(0.0001)	4-9 Vari-focal D/N filter	None	Visible
2	YCC-690RW-AZTHQ-4/9-32HS	D-True color(0.05) N-B/W(0.0000)	4-9 Vari-focal D/N filter	32 PCS	50M-Clean
3	YCC-940CW-AZTHQ-5/50-80HS	D-True color(0.05) N-B/W(0.0000)	5-50 Vari-focal D/N filter	80 PCS	100M-Clean
4	LVC-2700AZTHQ-5/50-250HS	D-True color(0.05) N-B/W(0.0000)	5-50 Vari-focal D/N filter	250 PCS	200M-Clean

T2, 4" or 5" Vandal-proof or Poly carbonate Dome to use Indoor/Outdoor



No	Model No	Sensitivity (LUX)	Lens(mm)	Strong" IR" LEDs (850S)	Image pick-up at night
1	VCD-400AZTHQ-4/9 (4" Vandal-proof)	D-True color(0.05) N-B/W(0.0001)	4-9 Vari-focal D/N filter	None	Visible
2	VCD-400-AZTHQ-4/9-32HS (4" Vandal-proof)	D-True color(0.05) N-B/W(0.0000)	4-9 Vari-focal D/N filter	32 PCS	30M-Clean
3	YCD-400AZTHQ-4/9 (4" PC Dome)	D-True color(0.05) N-B/W(0.0001)	4-9 Vari-focal D/N filter	NONE	Visible
4	YCD-400AZTHQ-4/9-32HS (4" PC Dome)	D-True color(0.05) N-B/W(0.0000)	4-9 Vari-focal D/N filter	32 PCS	30M-Clean
5	YCD-500AZTHQ-4/9 (5" PC Dome)	D-True color(0.05) N-B/W(0.0001)	4-9 Vari-focal D/N filter	NONE	Visible
6	YCD-500AZTHQ-4/9-32HS (5" PC Dome)	D-True color(0.05) N-B/W(0.0000)	4-9 Vari-focal D/N filter	32 PCS	30M-Clean

**T3 540TV Lines micro-bullet 1/3" Sony super-had HQ color CCD camera
Buitin 4~9mm Vari-focal zoom lens, weather-proof metal case
Day-true color/Night-0.0001 lux B/W night vision**

Model No	Lens	Ccd sensor	Sensitivity	Installation
YCC-270RW-MZHQ-4/9	4-9mm Vari-focal Manual Zoom	1/3" Sony super-had HQ	Day-true color Night-B/W	Indoor Outdoor
YCC-270RW-HQ-L3.6	3.6mm Fixed	1/3" Sony super-had HQ	Day-true color Night-B/W	Indoor Outdoor
YCC-300RWHQ-7DS	4.3mm Fixed	1/3" Sony super-had HQ	Day-color/ Night-10M(30Ft)	Indoor Outdoor



**T4 New generation 1/2" EX-View or 1/3" Sony Double Density Color CCD Box Camera with Motorized D/N filter
C/CS Mount 540TV Lines True color Day-0.01 Lux/Night-0.00001 Lux Ultra sensitivity B/W night vision color cameras**



- ◎ 410K/540TV Lines Day-true color/Night-0.00001 lux ultra sensitivity B/W night vision at night
- ◎ Buitin Motorized D/N filter & Sens-up circuits to make 0.00001 lux ultra sensitivity by auto or manual at night
- ◎ Buitin on screen display of MENU & adjust of privacy mask, WDR by dual shutter, Flickerless, Sens-





up, Motion Detector, etc.		
◎ C/CS Mount Box camera with CCD Moving frange back adjust mechanism		
◎ Built-in RS-232C or 485 to remote control of all functions by PC or Controller		
◎ DC12V or AC24V line lock – both operations		
Model NO.	LVC-SX701PC	LVC-740HQ
Image sensor	1/3" Sony double density color CCD	1/2" Sony EX-View HQ color CCD
Resolutions	410K / 540 TV Lines	410K / 540TV Lines
Sensitivity	Day-True color/Night-0.0001 lux B/W night vision by DSS	Day-true color / Night-0.00001 lux B/W night vision by sens-up circuits
Day-Night filter		Yes (motorized)
Sensitivity improve method	Digital Slow Shutter(DSS)	Sens-up circuits with Noise reduction (SSNR)
MENU OSD Functions	Privacy mask, WDR by dual shutter Flickerless, DSS Motion detector, etc.	Privacy Mask, WDR, Sens-up, Motion detection, Flickerless, SSNR, AGC-Torbo, etc.
Shutter speed	1/60~1/100,000 sec.	1/60 ~ 1/100,000 sec.
WDR	Yes	Yes
Motion Detector	Yes	Yes
IRIS Control	DC / ELC / Video selectable	DC / ELC / A.I / ESC
Power Supply	DC12V or AC24V Line lock	DC12V or AC24V Line lock
Weight	250gr	480gr
Dimensions	67(W)x59(H)x127.5(L)mm 2.63" x2.32" x5.01"	70(W)x56(H)x130(L)mm 2.75" x2.20" x5.11"

U	Wide angle "IR" beam illuminator with Indoor/Outdoor housing true color D/N cameras (IP66, -30°C~+55°C) "IP" Network P/T/Z cameras by using MPEG-4 A/V server – optional
----------	---

U1, Environmental Outdoor housing with fan & heater professional CCTV cameras to use hot & cold area (IP66)

- ◎ Built-in 6~60mm(10x) Motorized Zoom or x27 Auto zoom with x10 Digital zoom plus digital motion detector
- ◎ Built-in 104-Power "IR" illuminator to take 100M(300Ft) clean image pick-up at night
- ◎ Built-in RS-485/Pelco-D to use 255 zoom cameras Multi-remote control of Zoom/Focus/Menu control by DVR controller, "IR"remocon-optional

※ Built-in "IP" Network DVD level real-time image display with P/T/Z control, Wiper on-off, Speaking, Alarm identification on screen by client PC (Software program by F.0.C)

No	Model no	Lens	Image pick-up	Dimensions	Installation	
1	LVC-1800AZTFH-6060	6-60mm(10x) Motorized Zoom auto iris & D/N filter	Visible image 0.0001 lux at night	180(W)x150(H)x540(D)mm (7.08" x5.90" x21.25") 12kgs	Indoor/Outdoor Built-in fan & heater	 
2	LVC-1800AZTFH-6060-104DS	6-60mm(10x) Motorized Zoom & D/N filter plus 104-Strong IR illuminator	100M(300Ft)-Clean image pick-up at night	180(W)x150(H)x540(D)mm (7.08" x5.90" x21.25") 12kgs	Indoor/Outdoor Built-in fan & heater	
3	LVC-1800DN-270x	X27 Optical zoom with x10 digital zoom & D/N filter	Visible image pick-up 0.01 lux by D/N filter at night	180(W)x150(H)x540(D)mm (7.08" x5.90" x21.25") 12kgs	Indoor/Outdoor Built-in fan & heater RS-485/Pelco-D	<p>"Internet CCTV monitoring with zoom control by client PC, DVR by using Network video server such as traffic, street CCTV cameras" - Optional</p>  
4	LVC-1800DN-270x-104DS	X27 Optical zoom with x10 digital zoom & D/N filter Plus 104-strong IR illuminator	50M(150Ft)-Clean image pick-up at night	180(W)x150(H)x540(D)mm (7.08" x5.90" x21.25") 12kgs	Indoor/Outdoor Built-in fan & heater RS-485/Pelco-D	

U2, Bullet metal case with Sun shield, Bracket to use indoor/outdoor (IP66)

☉ Day-true color/Night-0.000 lux night vision by day-night filter plus wide angle strong IR beam illuminator about 10.0 lux automatically.(Camera & Illuminator together-wide angle)

☉ Built-in CdS sensor circuits to on-off illuminator about 10.0 lux & long life illuminator by +12V regulator circuits, Super sensitivity by power boost circuits.

※ Built-in "IP" Network DVD level real-time image display with P/T/Z control, Wiper on-off, Speaking, Alarm identification on screen by client PC (Software program by F.0.C)

No	Model No	IR leds	Image pick-up at night time	Dimensions	Installation	
1	LVC-2700DNFH-250DS RS-485/Pelco-D	850NM ±8°	100M(300Ft) clean x27 zoon day-night	Φ150-224mm Φ5.9"-8.81"	Indoor Outdoor	
2	LVC-2700AZTFH-5/50-250DS Long distance	850NM ±8°	150M(450Ft) clean 5-50mm tele-photo auto iris lens & D/N filter	Φ150-224mm Φ5.9"-8.81"	Indoor Outdoor	
3	LVC-940DNFH-94DS RS-485/Pelco-D	850NM ±8°	50M(150Ft) clean x27 zoon day-night	Φ94-187mm Φ3.70"-7.36"	Indoor Outdoor	
4	LVC-940AZTFH-5/50-80DS Medium distance	950NM 850NM ±8°	50M(150Ft) clean 100M(300Ft) clean 5-50mm tele-photo auto iris lens & D/N filter	Φ94-133mm Φ3.70"-5.23"	Indoor Outdoor	
5	LVC-940AZT-4/9-80DS Medium distance	950NM (Invisible)	50M(150Ft)-clean 4-9mm Vari-focal & auto iris & D/N filter	Φ94-133mm Φ3.70"-5.23"	Indoor Outdoor	
6	LVC-940AZT-4/9-80HS Medium distance	850NM	100M(300Ft)-clean 4-9mm Vari-focal & auto iris & D/N filter	Φ94-133mm Φ3.70"-5.23"	Indoor Outdoor	
7	YCC-690RW-AZT-4/9-32DS "Bullet metal"	950NM (Invisible)	20M(60Ft) clean 4-9mm vari-focal Auto iris & D/N filter	Φ69-90mm Φ2.91"-3.54"	Indoor Outdoor	
8	YCC-690RW-AZT-4/9-32HS "Bullet metal" "D/N filter"	850NM (Strong)	30M(90Ft) clean 4-9mm vari-focal Auto iris & D/N filter	Φ69-90mm Φ2.91"-3.54"	Indoor Outdoor	
9	LVC-3000HDN-96DS "Bullet metal" Digital slow shutter	950NM (Invisible)	30M(90Ft) clean 50M(150Ft) visible X27 Zoom day-night 0.0001 lux	Φ94-119mm Φ3.70"-4.68"	Indoor Outdoor Optional	
10	VCD-400AZT-32HS 4" Vandal dome	850NM (Strong)	30M(90Ft) clean 4-9mm Vari-focal Auto iris & D/N filter	Φ100-115mm Φ4.0"-4.52"	Indoor Outdoor	
11	VCD-400AZT-32DS 4" Vandal dome	950NM (Invisible)	20M(60Ft) clean 4-9mm Vari-focal Auto iris & D/N filter	Φ100-115mm Φ4.0"-4.52"	Indoor Outdoor	
12	YCD-400AZT-32DS 4" Vandal plastic dome	950NM (Invisible)	20M(60Ft) clean 4-9mm Vari-focal Auto iris & D/N filter	Φ100-115mm Φ4.0"-4.52"	Indoor	
13	YCD-400AZT-32HS 4" Vandal plastic dome	850NM (Strong)	30M(90Ft) clean 4-9mm Vari-focal Auto iris & D/N filter	Φ100-115mm Φ4.0"-4.52"	Indoor	

14	YCD-500AZT-32HS 5" Vandal plastic dome	850NM (Strong)	30M(90Ft) clean 4-9mm Vari-focal Auto iris & D/N filter	Φ120-140mm Φ5.0"-5.5"	Indoor	
15	YCD-500AZT-32DS 5" Vandal plastic dome	950NM (Invisible)	20M(60Ft) clean 4-9mm Vari-focal Auto iris & D/N filter	Φ120-140 mm Φ5.0"-5.5"	Indoor	

U3, Economic "IR" filter D/N Camera by 1/3" Sony super-had Color CCD Cameras

◎ Day-color/Night-0.000 lux night vision by IR filter plus IR illuminator at night automatically

◎ Built-in CdS sensor circuits to on-off illuminator about 10.0 lux & long life illuminator by +12V regulator circuits, Super sensitivity by power boost circuits to make EX-view sensitivity

※ Built-in "IP" Network DVD level real-time image display with P/T/Z control, Wiper on-off, Speaking, Alarm identification on screen by client PC (Software program by F.0.C)

No	Model No	IR leds	Image pick-up at night time	Dimensions	Installation	
1	YCC-520RW-24DS "BULLET METAL"	950NM 850NM	10M(30Ft) visible 10M(30Ft) clean	Φ50-67.5mm Φ1.96"-2.65"	Indoor Outdoor	
2	YCC-690RW-56DS "BULLET METAL"	950NM 850NM	20M(60Ft) visible 20M(60Ft) clean	Φ69-67.5mm Φ2.91"-2.65"	Indoor Outdoor	
3	YCC-940RW-104DS "BULLET METAL"	950NM 850NM	30M(90Ft) visible 30M(90Ft) clean	Φ94-67.5mm Φ3.70"-2.65"	Indoor Outdoor	
4	YBC-500RW-S25DS "B/W Bullet"	950NM 850NM	10M(30Ft) visible 10M(30Ft) clean	Φ50-67.5mm Φ1.96"-2.65"	Indoor Outdoor	
5	YBC-690RW-S56DS "B/W Bullet"	950NM 850NM	20M(60Ft) visible 20M(60Ft) clean	Φ69-67.5mm Φ2.91"-2.65"	Indoor Outdoor	
6	YBC-940RW-S104DS "B/W Bullet"	950NM 850NM	30M(90Ft) visible 30M(90Ft) clean	Φ94-67.5mm Φ3.70"-2.65"	Indoor Outdoor	
7	YCC-300RW-7DS Micro Bullet	950NM 850NM	5M(15Ft) visible 5M(15Ft) clean	Φ30-97.0mm Φ1.18"-3.81"	Indoor Outdoor	
8	LVC-250DNFH-250DS-L25 Long distance	850NM	100M(300Ft) clean	Φ150-224mm Φ5.9"-8.81"	Indoor Outdoor	
9	LVC-940RW-96DS-L25 Medium distance	850NM	50M(150Ft) clean	Φ94-187mm Φ3.70"-7.36"	Indoor Outdoor	
10	VCD-400-40DS VCD-400-40HS 4" Vandal dome	950NM 850NM	20M(60Ft) visible 20M(60Ft) clean	Φ100-115mm Φ4.0"-4.52"	Indoor Outdoor	
11	YCD-400-24DS YCD-400-24HS 4" Vandal plastic dome	950NM 850NM	20M(60Ft) visible 20M(60Ft) clean	Φ100-115mm Φ4.0"-4.52"	Indoor	
12	YCD-500-24HS	850NM Strong	20M-clean	Φ120-100mm Φ4.72"-3.93"	Indoor	

13	YCD-500-40DS 5" DOME	950NM 850NM	20M(60Ft) visible 20M(60Ft) clean	Φ120-100mm Φ4.72"-3.93"	Indoor	
14	YCD-500W-40DS 5" DOME	950NM 850NM	20M(60Ft) visible 20M(60Ft) clean	Φ120-100mm Φ4.72"-3.93"	Wall mount Indoor Outdoor	

**U4, Small & long distance Day-color/Night-20M(60Ft), 30M(90Ft), 50M(150Ft) clean image pick-up by strong "IR" illuminator about 10.0 lux at night automatically
Builtin Cooling Fan to use long life time (up to 5-years)**

No	Model No	Camera	Lens	"IR" LED	Image pick-up at night
1	YCC-520RW-24FS-850S	1/3" Sony super-had color, 270K/400TVL "Builtin Cooling Fan"	6.0mm Fixed "IR" filter	850NM strong "IR" -24 pcs Smog color	20M(60Ft)-clean
2	YCC-690RW-56FS-850S	Same "Builtin Cooling Fan"	Same	Same-56 pcs	30M(90Ft)-clean
3	YCC-940RW-104FS-850S	Same "Builtin Cooling Fan"	Same	Same-104 pcs	50M(150Ft)-clean



YCC-520RW-24FS-850S

YCC-690RW-56FS-850S

YCC-940RW-104FS-850S

V1 0.0001 lux star-light sensitivity Armor dome, bullet, Box color cameras by day-night filter & 4-9mm Vari-focal auto iris lens, Builtin power boost circuits to make EX-View sensitivity by using 1/3"sony super had color ccd.					
No	Model No	Lens	Ccd sensor	Sensitivity	Installation
1	YCC-500RW-AZT	4-9mm vari-focal auto iris & D/N filter	1/3" Sony super-had	Day-true color/ Night-0.0001 lux	Indoor/Outdoor
2	LVC-4101 "400 TVL"	C/CS mount Day-night filter	1/3" Spny ex-view ccd	Day-true color/ Night-0.0001 lux	Indoor only
3	LVC-4102 "480TVL"	C/CS mount Day-night filter	1/3" Spny ex-view ccd	Day-true color/ Night-0.005 lux	Indoor only
4	VCD-020SDN-F/S	3.6mm Fixed "IR" filter	1/3" Sony super-had color	0.01 Lux Day-Night	Indoor only
5	VCD-020SH-F/S	3.6mm Fixed	1/4" Sharp color	0.5 Lux	Indoor only
6	VBD-020SDN-F/S	3.6mm Fixed	1/3" Super-had B/W	0.01 Lux	Indoor only
7	VBD-020SS-F/S	3.6mm Fixed	1/3" Samsung	0.05 Lux	Indoor only



8	VCD-400AZT-4/9 4" Vandal dome	4-9mm Vari-focal zoom auto iris & D/N filter	1/3" sony super-had color CCD	Day-true color/ Night-0.0001 lux	Indoor Outdoor	
9	VCD-400-L3.6 4" Vandal dome	3.6mm Fixed "IR" filter	1/3" sony super-had color	D/N-0.01 lux	Indoor Outdoor	
10	VBD-400-L3.6 4" Vandal dome	3.6mm Fixed "IR" filter	1/3" sony super-had B/W	D/N-0.01 lux	Indoor Outdoor	
11	YCD-400AZT-4/9 4" Vandal plastic dome	4-9mm Vari-focal zoom auto iris & D/N filter	1/3" Sony super-had color	Day-true color/ Night-0.0001 lux	Indoor only	
12	YCD-400-L3.6 4" Vandal plastic dome	3.6mm Fixed "IR" filter	1/3" Sony super-had color ccd	0.01 Lux D/N	Indoor only	
13	YBD-400-SS	3.6mm Fixed	1/3" B/W ccd	0.05 Lux	Indoor only	 
14	YCD-500-AZT-4/9 5" Shutter Dome	4-9 vari-focal zoom auto iris & D/N filter	1/3" Sony super-had ccd	Day-true color/ Night-0.0001 lux	Indoor only	
15	YCD-500W-AZT- 4/9 "Wall mount"	4-9 vari-focal zoom auto iris & D/N filter	1/3" Sony super-had ccd	Day-true color/ Night-0.0001 lux	Indoor Outdoor	
16	YCC-690CW-AZT- 5/50 "Bullet acetal"	5-50 vari-focal zoom auto iris & D/N filter	1/3" Sony super-had ccd	Day-true color/ Night-0.0001 lux	Indoor Outdoor	
17	YCC-690CW-AZN- 5/50 "Bullet metal"	5-50 Vari-focal zoom auto iris color	1/3" Sony super-had ccd	0.1 Lux-Nomal 0.01 Lux-"IR"	Indoor Outdoor	
18	YCC-690CW-MZN- 5/50 "Bullet metal"	5-50 Vari-focal zoom electronic iris, color	1/3" Sony super-had ccd	0.5 Lux-Nomal 0.05 Lux-"IR"	Indoor Outdoor	
19	YBC-690CW-AZN- 5/50 "Bullet metal"	5-50 Vari-focal zoom auto iris B/W	1/3" Sony super-had ccd	0.1 Lux-Nomal 0.01 Lux-"IR"	Indoor Outdoor	
20	YBC-690CW-MZN- 5/50 "Bullet metal"	5-50 Vari-focal zoom electronic iris, B/W	1/3" Sony super-had ccd	0.5 Lux-Nomal 0.05 Lux-"IR"	Indoor Outdoor	

V2 Super sensitivity micro board cameras-0.005 lux by power boost circuits to make EX-view CCD.

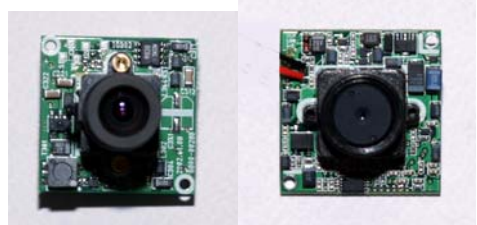

Model no	Description	
YMC-3232FP	Color flat pinhole lens, 32x32-1 board, 0.005 lux	
YMC-3223CP	Color cone pinhole lens, Same above, 0.005 lux	
YMB-3232FP	B/W flat pinhole lens, 32x32-1 board, 0.005 lux	
YMB-3232CP	B/W cone pinhole lens, 32x32-1 board, 0.005 lux	



**W 100% Under-water color or B/W cameras more than 50M(150Ft) inside water (IP68)
100% Water-proof cable 10M, 50M, 100M, 200M (optional)-IP68**

No	Model No	Camera	Case material	Dimensions	
1	YCC-2000LWW-6S	1/4" Color ccd with 6-white lamp	Metal case Epoxy bond	Φ20-72mm Snake color cameras	
2	YBC-2000LWW-6S	1/3" B/W ccd with 6-white lamp	Metal case Epoxy bond	Φ20-62mm Snake B/W cameras	
3	YCC-300LWW-6S	1/3" Sony super-had color	Metal case Epoxy bond	Φ30-80mm Miniature	

4	YCC-300LWW-6GLS	1/3" Sony super-had color	Metal case Epoxy bond	Φ30-80mm 5M-glass rod 1.2M-folded	
5	YCC-350LWW-6S	1/3" Sony super-had color	Metal case Epoxy bond	Φ34-78mm Miniature	
6	YCC-350LWW-6GLS	1/3" Sony super-had color	Metal case Epoxy bond	Φ34-78mm 5M-glass rod 1.2M-folded	
7	YBC-350LWW-6S	1/3" Sony super-had B/W	Metal case Epoxy bond	Φ34-48mm B/W standard	
8	YCC-650LWW-45S "Strong light"	1/3" Sony super-had color	Acetal case Epoxy bond	Φ65-57.5mm Chemical pool	
9	YCC-650LWW-45GLS	1/3" Sony super-had color	Acetal case Epoxy bond	Φ65-57.5mm 5M-glass rod 1.2M-folded	
10	YBC-650LWW-40S "Strong light"	1/3" Sony super-had B/W	Acetal case Epoxy bond	Φ65-57.5mm Chemical pool	
11	YCC-5000WW-27S "Strong light"	X16 Auto zoom color camera 410K, 480TVL	Acetal case Epoxy bond Metal case	Φ71-123mm Chemical pool Inside water	
12	YCC-5000WW-27GLS "Strong light"	X16 Auto zoom color camera 410K, 480TVL	Acetal case Epoxy bond Metal case	Φ71-123mm 5M-glass rod 1.2M-folded	
13	YCC-7000WW-48S "Strong light"	X22 Auto zoom color camera 410K, 480TVL	Metal case Epoxy bond	Φ82-123mm Inside water	
14	YCC-7000WW-48S-D/N "Strong light" Day-night filter	X27 Auto zoom day-night Night-0.01lux B/W 410K, 480TVL	Metal case Epoxy bond	Φ82-123mm Inside water	
15	YCC-7000WW-48GLS "Strong light"	X22 Auto zoom color camera 410K, 480TVL	Metal case Epoxy bond	Φ82-123mm 5M-glass rod 1.2M-folded	
16	YUC-10	10M(30Ft)-Under-water cable with water-proof receptacle to use 50m(150fT) inside water or sea			
17	YUC-30	Same above with 30M(90Ft)			
18	YUC-50	Same above with 50M(150Ft)			
19	YRL-10	10M(30Ft)-Under water cable with wheel assy			
20	YRL-30	30M(90Ft)-Under water cable with wheel assy			
21	YRL-50	50M(150Ft)-Under water cable with wheel assy			
22	YST-350LWW-5.6"	AL-suit case with 5.6" color LCD monitor plus recharge battery & circuits			
23	YST-350LWW-10.4"	Same above with 10.4" color LCD monitor			

X		Power zoom magnification cameras to use low vision or visually impaired	
		Flexible or table type bracket & X-Y moving table- optional	
No	Model no	Description	
1	LVC-1000HM +5.00/+3.50	x5~x50 Power zoom magnification by +1.00 swing away macro lens to use leading & writing plus long distance leading letters on blackboard by open of swing away lens at school. Included camera mounting bracket Builtin wireless(IR) remocon to remote control of all function	
2	MVS-1000HM	Same above with X-Y moving table to easy reading or writing	
3	LVC-2200HM +5.00/+3.50	x5~x60 Power zoom magnification by +5.00 macro lens to use leading & writing, builtin wired remocon	
4	MVS-300 -10x/30x	x10~x30 magnification color camera to use reading only. Large/Small/Negative/Color/Power control button Builtin 6-white leds lamp	

5	MVS-300RW -10x/30x	x10~x30 magnification color camera with fixable arm bracket to use reading & writing,	 
6	MVS-100-10x	x10 fixed magnification color camera with flexible arm bracket to use reading & writing, builtin 6-white leds lamp	
7	MVS-150-10x	x10 fixed magnification color camera to use reading only Builtin 6-white lamp, economic price!!!	
8	YIC-1000VGA	4CH. Image capture & compare with still or moving image VGA input/output to use PC or VGA monitor	
9	YST-560-5.6" YST-560-10.4"	AL-suit case with 5.6" or 10.4" color TFT LCD monitor to use above all magnification cameras	
10	YTM-560	5.6" Color LCD monitor w/t bracket	
11	YTM-104	10.4" Color LCD monitor w/t bracket	
12	HL-4210VR	42" LCD Monitor, all functions	
12	LG-110A	X-Y line moving generator to use easy reading of book to use low vision or visually impaired.	

Y Professional dummy camera with interval flashing LED on-off circuits automatically			
NO	MODEL NO	DESCRIPTION	
1	YDM-450BX	Box type plastic case to use indoor 54(W)x40(H)x116(D)mm / (2.12"x1.57"x4.56") 6-Month operating time by 2-"A" batteries	  
2	YCD-400DM	4" Dome type to use indoor φ100-70mm(φ4.0"x2.75") 6-Month operating time by 2-"A" batteries	
3	YDM-750RW	100% Weather-proof metal case with sun shield & braket to use indoor/outdoor φ75-190mm(φ2.95"x7.48") 6-Month operating time by 2-"A" batteries	

Z Additional Items			
1	MODEL NO	DESCRIPTION	
1	YMD-11	Digital motion detector to use all CCTV cameras	   
2	VAMS-0808	8CH. Video/audio matrix switcher	
3	YTX-310/YRX-310	2.4GHz TX/RX 4CH.-Manual selection	
4	YRA-100	2.4GHz RF AMP. 100mW output	
5	YRA-300	2.4GHz RF AMP. 300mW output	
6	YRA-500	2.4GHz RF AMP. 500mW output	
7	HPW-2400Y	2.4GHz Yagi-antenna, +16dB Weather-proof case to use outdoor	
8	HWPT-2350A	2.4GHz Patch-antenna, +12dB Weather-proof case to use outdoor	
9	YRT-960HR	Joggle shuttle 40HR real time with 960HR TLR	
10	YMV-960HR	Mobil vision 40HR real time with 960HR TLR (DC12V)	
11	YH-1610F	16CH. Real time multiplexor, 5-output (720x480)	
12	YH-910F	9CH. Real time multiplexor, 3-output (720x480)	
13	YCM-1400	Professional 14" color monitor Metal case, NTSC/PAL auto switchable	
14	YCM-1400Q	Same above with real time QUAD	
15	YCM-2100	Professional 21" color monitor NTSC/PAL auto switchable	
16	YRB-300	Rechargeable battery pack, DC12V/3.0AMP.	
17	J1-88H	Garette type hand held metal detector	
18	J1-89A	Standard type hand held metal detector	

19	J1-89H	Long stick type hand held metal detector	
20	J1-90H	Miniature hand held metal detector	
21	PC-1200	Wake-through Metal detector with bar LEDS indicator	
22	DMS-100	x50, x200, x500 Interchangeable magnification lens video microscope with leds lamp & height control stand to inspection of integrated circuits(IC) , micro parts, microorganism, finger wave, skin treatment, etc.	
	x5~x500 Video microscope	1/3" Sony super-had color CCD camera, 410K/480TVL lens DC12C/500mA (3.0Watts)	

Accessories cable assy

NO	MODEL NO	DESCRIPTION	
1	YCB-2	Y-CABLE, DC JACK TO 2-DC PLUG	
2	YCB-3	W-CABLE, DC JACK TO 3-DC PLUG	
3	YRC-10	10M(30Ft) DC JACK/RCA PLUG/RCA PLUG TO DC PLUG/RCA PLUG/RCA PLUG ASSY	
4	YRC-20	20M(60Ft) DC JACK/RCA PLUG/RCA PLUG TO DC PLUG/RCA PLUG/RCA PLUG ASSY	
5	YRC-30	30M(90Ft) DC JACK/RCA PLUG/RCA PLUG TO DC PLUG/RCA PLUG/RCA PLUG ASSY	
6	YWC-18	18M(30Ft) WEATHER-PROOF CABLE ASSY	
7	YWC-DRC	0.5M(1.5Ft) WEATHER-PROOF JACK TO DC/RCA/RCA/RCA CONVERTOR, FAMILY WITH YWC-18	

Cameras mounting bracket

NO	MODEL NO	DESCRIPTION	
1	YBL-45	STREIGHT TYPE, L-45mm	
2	YBL-60	STREIGHT TYPE, L-60mm	
3	YBL-115	STREIGHT TYPE, L-115mm	
4	YCB-100	CLAMP TYPE: L-130mm	
5	YIB-100	I-SHAPE HEAVY DUTY: L-150mm	
6	YBL-1000	1M LONG STREIGHT TYPE: L-1000mm	

Pole Mounting Bracket with arrestor to use YPZ-5000W/3000W series models

1	YPL-4000	4M-Height with arrestor
2	YPL-6000	6-Height with arrestor
Pole Mounting Bracket to use wireless bridge		
1	WLE-VPB-40	400mm (H) - Angle type
2	WLE-VPB-70	700mm (H) - Angle type
3	WLE-VPI40	400mm (H) - Straight type
4	WLE-VPI70	700mm (H) - Straight type
Weather-proof outdoor housing (IP66)		
1	YOH-HPPoE	To use YPZ-3000W-2700DNFH-21SS-IP (+)Wireless Bridge - Outdoor(IP66)
2	YOH-PoE	To use Wireless Bridge - Outdoor(IP66)



Connection diagrams of 255-P/T/Z cameras multi-remote control by DVR, computer, Remocon

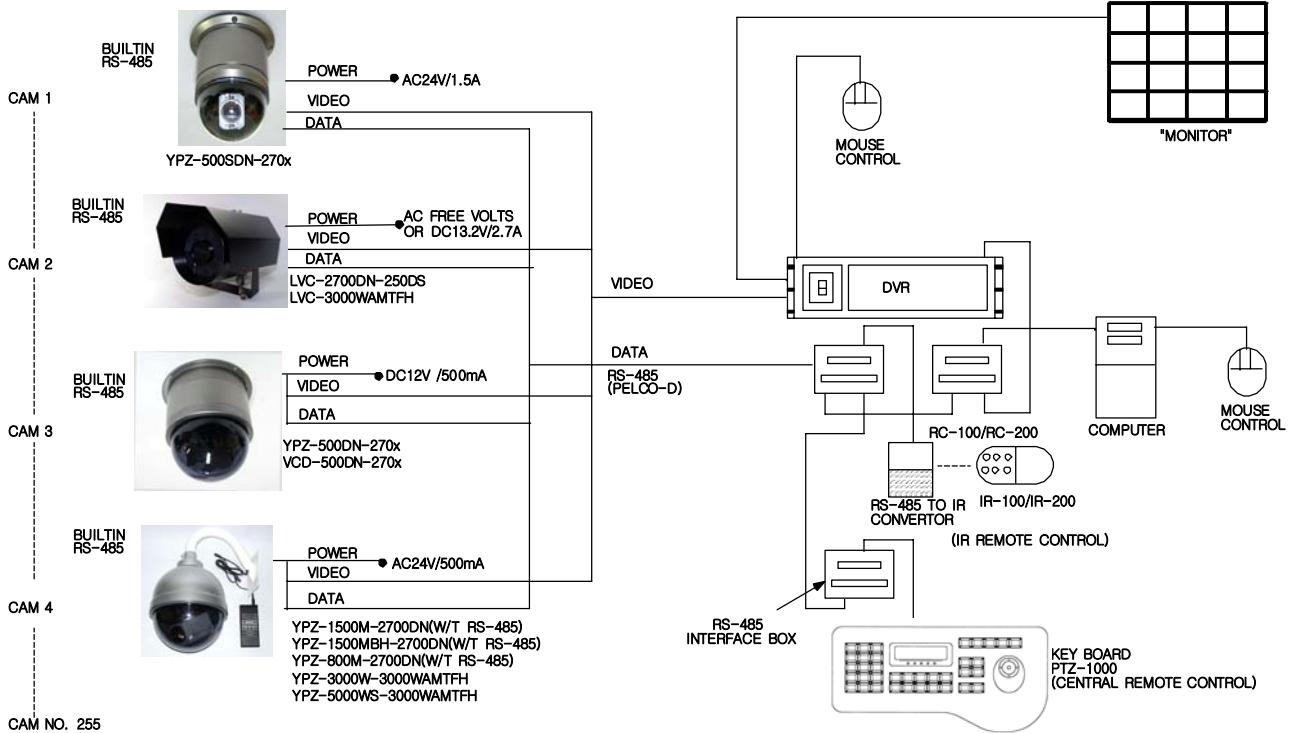

© Bultin RS-485 Pan/Tilt/Zoom or Zoom cameras such as YPZ-500SDN-270x, YPZ-500DN-270x, YPZ-800M, YPZ-1500M/MBH, LVC-2700DN-250DS, LVC-940DN-94DS etc.

Connection diagrams of RS-485 Matrix System to use Multi-remote control of MAX, 255-P/T/Z cameras and Matrix switcher by Keyboard Controller together

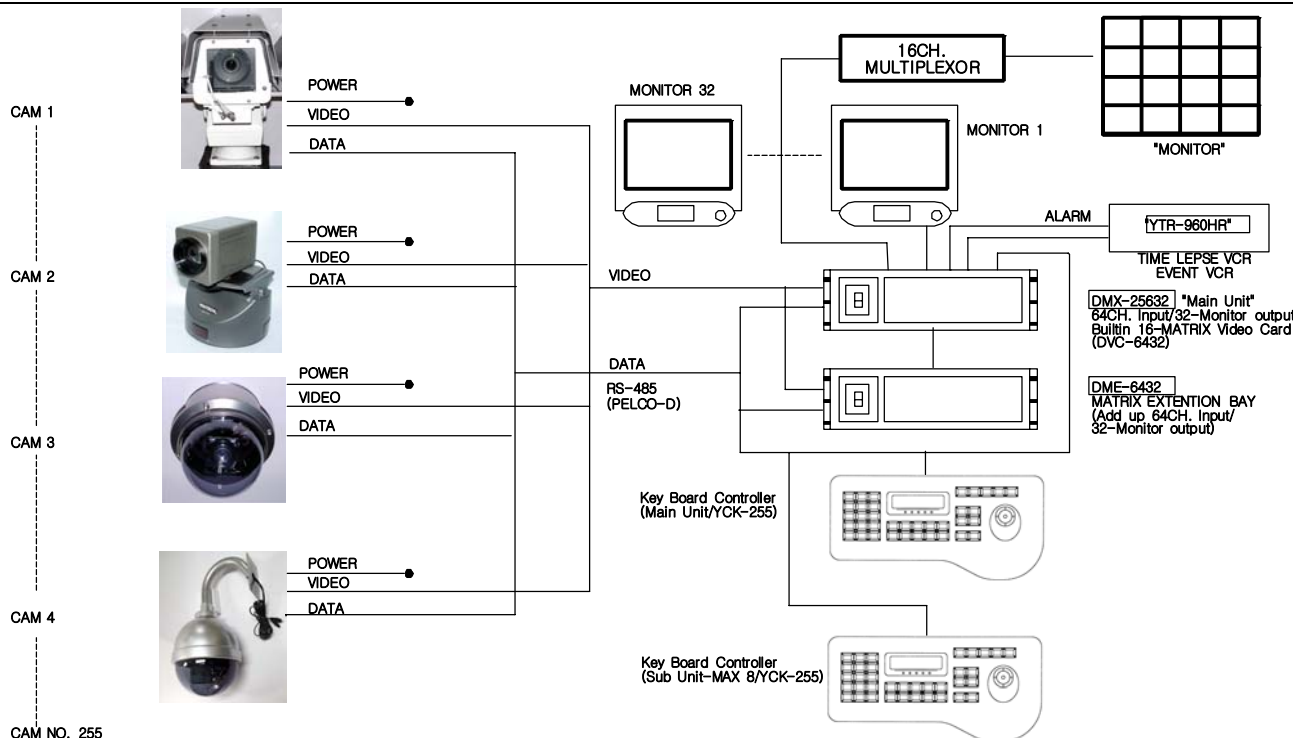

© MAX. 255-Pan/Tilt/Zoom or Zoom Camera Multi-Remote control by using RS-485/Pelco protocol RX.

39-Years experienced new generation items

Built-in "IP" Network DVD level real-time image display with P/T/Z control, Wiper on-off, Speaking, Alarm identification on screen by client PC (Software program by F.O.C)



360 ° Endless or 350 ° Economic high speed heavy duty Pan/Tilt machine with 10~1000/20~2000(100x), 12.5~750/25~1500mm(60x), 10~300mm(30x), 10~200mm(20x) Motorized Zoom true color D/N-1KM(3,000Ft) image pick-up by 56-strong "IR" illuminator with collimator lens at night (IP66, 20kg)
 Built-in RS-485/Pelco-D RX to use Max. 255 multi-remote control of Pan/Tilt/Zoom/64-Preset/8x8 Tour & Group display by DVR, Controller, "IR" remote (IRC-200), AC24V or DC24V
Application area: Airport, Seaport, Oil plant, Big palm, Sea-side, Military zone, etc.

<p>Explosion-proof stainless steel case 350° heavy duty P/T/Zoom camera (IP66) RS-485/Pelco-D RX. DC12V</p>	<p>MPEG-4 Network video & 2-way audio</p> <ul style="list-style-type: none"> • Dynamic "IP" supported web based access by PC, PDA, Mobil • Acceptable our all cameras 	<p>5" Vandal dome with 340° speed P/T/27x Zoom D/N-0.0001 lux B/W night vision by D/N filter & DSS Economic price!!! (IP66), DC12V</p>
	 <p>※ Complete board of MPEG-4 Video/Audio server available</p>	
<p>Mobil vision heavy duty P/T/27x Zoom D/N-100M(300Ft) image pick-up at night RS-485/Pelco-D RX. (IP66, DC12V)</p>	<p>"IP" Network true color D/N-50M(150Ft) clean image pick-up color cameras(IP66) Video & 2-way audio by PC, PDA, Mobil, DVR, DC12V/1.3A (16W)</p>	<p>Snake type under-water color camera with light (IP68) Water-proof cable & connector DC12V/0.2A (2.4W)</p>
		

System Integration (SI) of long distance P/T/Z control by "IP" Technology

Camera Site

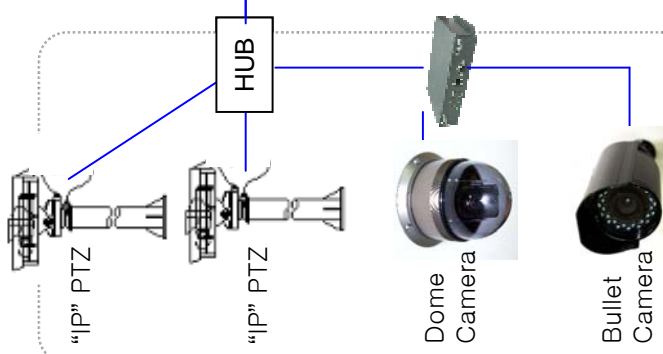

- Builtin MPEG-4 Video server PTZ with wiper, Alarm
- Motorized Zoom 15KM(12.5~1500mm), 5KM(23~506mm), 2.5KM(10~200mm)
- MIC & Speaker – optional

Long distance

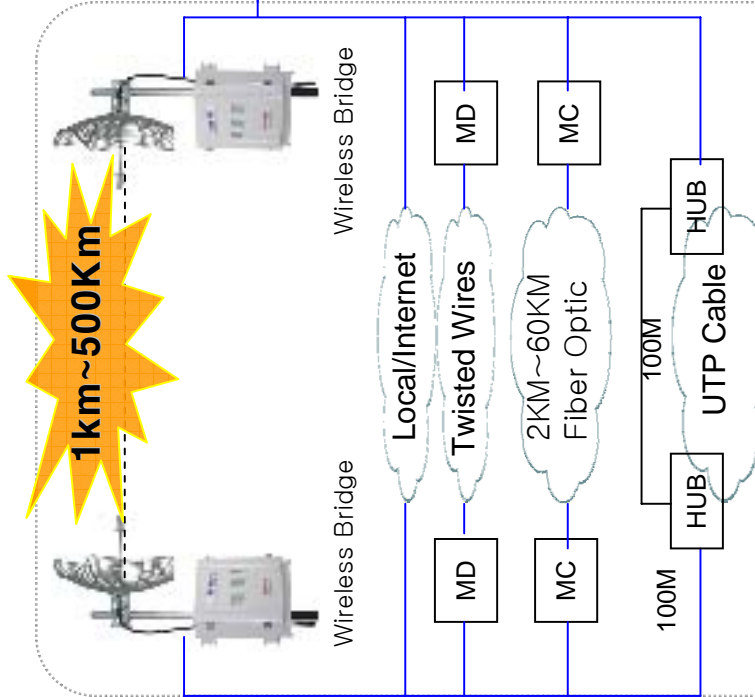

- Wireless bridge: 1KM~500KM arrangeable 2.4GHz/5.7GHz Free Band or 2~6GHz OEM
- Fiber Optic by using Multi-Media converter
- UPT Cable by short distance about 100M & add up HUB to make 200M~2km.
- Internet-World wide viewing image with PTZ control, wiping, 2-way audio by client PC.
- MODEM with Twisted wire : up to 3km IP PTZ control.

Monitoring & Control Site

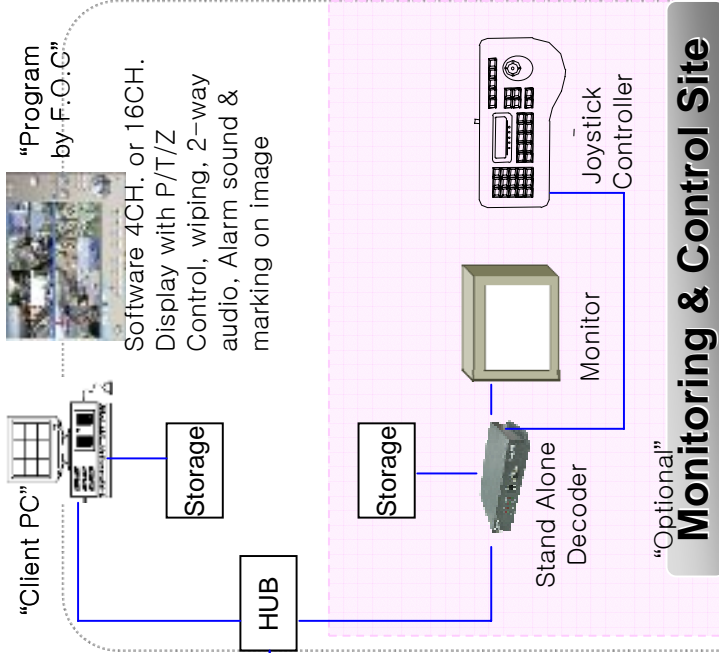

Software 4CH. or 16CH.
Display with P/T/Z
Control, wiping, 2-way
audio, Alarm sound &
marking on image

"Optional" Monitoring & Control Site

- Software 1CH. 4CH. 16CH. Image display with PTZ control, wiping, 2-way audio, Alarm sound & marking on the picture
- Hardware image display with joystick PTZ control & recording by Decoder – optional