

SPECIAL CCTV CAMERA & SYSTEM



*“360° Speed dome Pan/Tilt/x27 Zoom day-night camera*

*128-Preset & Tour, Pattern, Group display, RS-485/Pelco-D or P Protocol*

*“Internet CCTV system to use traffic, office, home, shop, long distance image observation with P/T/Zoom control by client PC or DVR by using Network video server (NVS-100PTZ)”*

*“Clean image pick-up distance more than 5M(15Ft), 10M(30Ft), 20M(60Ft), 30M(90Ft), 50M(150Ft), 100M(300Ft), 200M(600Ft), 1KM(3,000Ft) day-true color/night-0.0000 lux night vision cameras by your choice”*

- A. 360° Rotating speed dome Pan/Tilt/Zoom cameras
- B. 100% Outdoor Pan/tilt/x27 Zoom D/N camera with strong “IR” illuminator to use cold or hot area
- C. Economic Pan/Tilt/Zoom or Vari-focal zoom camera
- D. Central remote controller to use speed dome cameras.
- E. Network video server to use internet CCTV observation with Pan/Tilt/Zoom control by client PC, DVR
- F. x27 optical zoom with x10 digital zoom D/N-0.01 lux B/W night vision
- G. 0.0001 Lux star-light super sensitivity color camera by D/N filter, 4-9mm Vari-focal auto iris lens
- H. Invisible or Visible IR illuminator – Clean image pick-up 10M, 30M, 50M, 100M, 200M, 1KM
- I. Outdoor housing with cooling fan & heater environmental CCTV cameras to use on boat, traffic, seaside
- J. True color D/N camera with illuminator – 10M, 20M, 30M, 50M, 100M, 200M – Clean image at night
- K. “IR” D/N color camera with illuminator – 10M, 20M, 30M, 50M, 100M, 200M – Clean image at night
- L. M. Micro bullet camera & board camera
- N. Professional dummy cameras-Box type, dome type, 100% weather-proof metal case
- O. 100% under-water camera & cables
- P. Power zoom low vision cameras & systems, AL-suit case with 5.6” or 10.4” LCD monitor
- Q. Additional items-DVR, motion detector, 2.4GHZ TX/RX/AMP./ANT. 960HR TLR, Multiplexor, Metal detector, 14” or 21” color monitor, Video switcher
- R. Accessories

A. 360° Rotating speed dome Pan/Tilt/x27 Zoom day-night camera  
 320° Rotating speed dome Pan/Tilt/x27 Zoom day-night camera  
 5"Vandal & Weather-proof dome to use indoor/outdoor  
 Builtin RS-485/Pelco-D & P protocol to use 255-P/T/Z cameras multi-remote control by  
 DVR, computer, remocon (optional), Flush or Surface mount both available  
 Internet CCTV system to use Traffic, Office, Home image observation with P/T/Z control  
 by client PC or DVR by using Network video server (NVS-100PTZ)-optional

Model no.	Camera	RS-485	Sensitivity	Installation	Remarks
YPZ-500SDN-360° "Full functions" "High speed"	X27 Zoom day-night X10 Digital zoom AC24V/1.0 AMP.	Yes Pelco-D, P	Day-True color/ Night-0.01 lux with WDR (Super back light)	Indoor Outdoor AC24V	360°-Speed dome P/T/Z 128-Preset & Pattern, Tour, Group display function
YPZ-500DN-340° "Pan/Tilt/Zoom/Focus" "High Speed"	X27 Zoom day-night X10 Digital zoom	Yes Pelco-D	Day-true color/ Night-0.01 lux B/W night vision	Indoor Outdoor	340°-Speed dome P/T/Z Economic price DC12V/500mA
YPZ-700-340°	X 16 Zoom X10 Digital zoom	Yes Pelco-D	0.05 lux	Indoor Outdoor	340°-Speed dome P/T/Z Low price, DC12V/500mA
YOH-800FH	8"Dome 100% weather-proof outdoor housing with cooling fan & heater to use cold or hot area, Family with YPZ-500SDN, YPZ-500DN, YPZ-700, AC24V/0.5 AMP.				
YCH-800	In ceiling housing (TEX mount) to use YOH-800FH				
YCA-800	Coner mount adaptor to use YOH-800FH				
YPA-800	Pole mount adaptor to use YOH-800FH				
YPZ-800M/MBH-2700DN Builtin Blower & heater	X27 Zoom day-night X10 Digital zoom	Yes Pelco-D	Day-true color/Night- 0.01 lux B/W night vision	Indoor Outdoor	8"Metal dome 340°Slow speed Pan/Tilt/Zoom/Focus/Menu/Auto pan control, DC12V/1.0 AMP.
YPZ-1500M/MBH- 2700DN AC24V/1.0AMP.	X27 Zoom day-night X10 Digital zoom	Yes Pelco-D	Day-true color/Night- 0.01 lux B/W night vision	Indoor Outdoor	10"Vandal & Weather-proof dome 340°Slow speed Pan/Tilt/Zoom Builtin blower heater(MBH)



B. 100% Weather-proof heavy duty pan/tilt/zoom day-night cameras by DC12V to  
 use mobil vision or outdoor – Very strong mechanism (MAX. Loading 5kg)  
 Builtin CdS sensor circuits to on-off illuminator about 10.0 lux & long life illuminator by +12V  
 regulator circuits. Super sensitivity by power boost circuits same as EX-view CCD.  
 Builtin RS-485/Pelco-D to use 255-P/T/Z cameras multi-remote control of Pan/Tilt/Zoom  
 /Focus/ Menu/Auto pan on-off by DVR, Pelco-D controller, "IR" remocon (optional)  
 Internet CCTV observation with Zoom/Focus/Menu control by Client PC or DVR by using  
 Network video server (NVS-100PTZ) to use traffic monitoring-optional

Model No	camera	IR leds	Image pick-up at night	Installation	
YPZ-1000W "Strong mechanism"	Pan/tilt only DC operation	RS-485 available	None +12V/500mA	Indoor Outdoor	
YPZ-1000W- 940DNFH-940DS	X27 Zoom day- night	850NM IR-94 pcs	50M-clean 100M-visible	Indoor Outdoor	
YPZ-1000W- 940AZTFH-94DS	5-50mm vari- focal day-night	850NM IR-94 pcs	100M-clean 150M-visible	Indoor Outdoor	

YPZ-1000W-2700DNFH	X27 Zoom Day-night	850NM Strong IR-250 pcs	100M-clean 150M-visible	Indoor Outdoor	
YPZ-1000W-2700AZTFH - 250DS+RS485/Pelco-D	5-50mm Tele-photo zoom day/night	850NM Strong IR-250 pcs	150M-clean 200M-visible	Indoor Outdoor	

**C. Economic Type Pan/Tilt/Zoom or Vari-focal Zoom cameras-DC12V operation**  
 Builtin RS-485/Pelco-D to use 255-P/T/Z cameras multi-remote control of Pan/Tilt/Zoom/ Focus/Menu/Auto pan on-off by DVR, Pelco-D controller“IR”remocon (optional)  
 Internet CCTV system to use Traffic, Office, Home image observation with P/T/Z control by client PC or DVR by using Network video server(NVS-100PTZ) - optional

Model no	Dome	Camera	Sensitivity	Installation	Remarks
YPT-100-AZT 4"Dome	4"Dome Day-night filter	1/3"Sony ex-view ccd	Day-true color/ night-0.0001 lux	Indoor only RS-485	Miniature speed dome Builtin RS-485/Pelco-D protocol
YPT-100-C/D 4"Dome	4"Dome 410K, 480TVL	1/3"Super-had X3 Digital zoom	0.1 Lux normal 0.01 Lux IR	Indoor only RS-485	Miniature speed dome Builtin RS-485/Pelco-D protocol
GAC-PT1	Pan/Tilt only	None	None	Indoor	Heavy duty-max. Loading 4kgs.
GAC-PT1+RS-485	Pan/Tilt only	None	None	Indoor	Same above, Pelco-D
GAC-PT1+LVC-2701DN RS-485/Pelco-D	None Day-night filter	X27 Zoom day-night	Day-true color/ night-0.01 lux	Indoor only	Pan/Tilt/x27 Zoom day-night
YPZ-800+2700DN	8"Dome Day-night filter	X27 Zoom day-night	Day-true color/ night-0.01 lux	Indoor Outdoor	8"Weather-proof dome to use indoor/outdoor
YPZ-800-2700DN- RS485/Pelco-D	8"Dome Day-night filter	X27 Zoom day-night	Day-true color/ night-0.01 lux	Indoor Outdoor	Same above with RS-485/Pelco-D receiver



**D. 255 PCS-Speed dome multi-central remote controller to use speed dome for Tour, Group, Pattern display by using RS-485/Pelco-D, P protocol**  
 Wireless remote control of speed dome or slow dome by IRC-200 or IRC-100

Model no	Descriptions	Acceptable model
PTZ-1000	2-Axis Joy-stic to use speed Pan/Tilt & zoom control by RS-485/Pelco-D or P & others, DC12V/450mA	YPZ-500SDN, YPZ-500DN, YPZ-800M, YPZ-1500M & other speed dome Pan/Tilt/Zoom cameras
PTZ-2000	3-Axis Joy-stic to use speed Pan/Tilt/Zoom-in/Zoom-out control by RS-485/Pelco-D or P & others, DC12V/450mA	
IRC-200	Wireless remote control by "IR" remocon by using "IR" to RS-485 converter, same control function of PTZ-1000 or PTZ-2000	Same above
IRC-100	Wireless remote control by "IR" remocon by using "IR" to RS-485 converter, RS-485/Pelco-D protocol	YPZ-500DN, YPZ-800M, YPZ-1500M/MBH, YPT-100 Series models



**E. Miniature network video server to use internet CCTV observation & P/T/Z control**

Model no	Description	
NVS-100PTZ	Embadded LINUX type M-JPEC video server to use internet CCTV observation with Pan/Tilt/Zoom Control to use YPZ-500SDN, YPZ-500DN, YPZ-800M, YPZ-1500M, YPT-100AZT, C/D, C, B by RS-485 / Pelco-D protocol	
NVS-100Z	Embadded LINUX type M-JPEC video server to use internet CCTV observation with zoom control to use zoom camera such as LVC-2700DN, 3000DN, VCD-500DN-270x, LVC-2700DN-250DS, LVC-940DN-94DS, LVC-1800DN-270x.	

**F. X27 Optical zoom with X216 digital zoom & digital motion detector, Available digital slow shutter (DSS) to take 0.0001 lux star-light sensitivity Builtin RS-485/Pelco-D to use 255-Zoom cameras multi-remote control of Zoom/Focus/ Menu/Digital-Pan/Tilt/Auto pan by DVR, Pelco-D controller, "IR"remocon (optional) Internet CCTV system to use Traffic, Office, Home image observation with zoom control by client PC or DVR by using Network video server(NVS-100Z)**

Model no	Lens	CCD sensor	Sensitivity	Installation	
LVC-2700DN-27x/216x with DSS	X27 Optical zoom day-night	1/4"IT ccd 410K, 480TVL	Day-true color/ Night-0.01 lux Night-0.0001 lux	Indoor only optional cable assy-20M(60Ft), 30M(90Ft), 100M(300Ft)	
LVC-3000HDN-27x/216x with DSS	X27 Optical zoom day-night	1/4"IT ccd 410K, 480TVL	Day-true color/ Night-0.01 lux Night-0.0001 lux	Indoor/Outdoor 100% weather-proof metal	
VCD-500DN-270x 5"Vandal dome with DSS	X27 Zoom Day-night	1/4"IT Sony super-had	Day-true color Night-0.01 lux B/W Night-0.0001 lux	Indoor/Outdoor Flush mount or Surface mount	
VCD-500-160x 5"Vandal dome	X16 Zoom	1/4"IT sony super-had	0.05 lux	both available RS-485/Pelco-D	

**G. 0.0001 lux star-light sensitivity Armor dome, bullet, Box color cameras by day-night filter & 4-9mm Vari-focal auto iris lens, Builtin power boost circuits to make EX-View sensitivity by using 1/3"sony super had color ccd. Internet CCTV system to use traffic, office, home image observation by client PC or DVR by using network video server (NVS-100PTZ) - optional**

Model No	Lens	Ccd sensor	Sensitivity	Installation	
YCC-500RW-AZT	4-9mm vari-focal auto iris & D/N filter	1/3" Sony super-had	Day-true color/ Night-0.0001 lux	Indoor/Outdoor	
LVC-4101 "400 TVL"	C/CS mount Day-night filter	1/3"Spny ex-view ccd	Day-true color/ Night-0.0001 lux	Indoor only	
LVC-4102 "480TVL"	C/CS mount Day-night filter	1/3"Spny ex-view ccd	Day-true color/ Night-0.005 lux	Indoor only	
VCD-020SDN-F/S	3.6mm Fixed "IR" filter	1/3"Sony super-had	0.01 Lux Day-Night	Indoor only	

VCD-020SH-F/S	3.6mm Fixed	1/4" Sharp color	0.5 Lux	Indoor only	
VBD-020SDN-F/S	3.6mm Fixed	1/3" Super-had B/W	0.01 Lux	Indoor only	
VBD-020SS-F/S	3.6mm Fixed	1/3"Samsung	0.05 Lux	Indoor only	
VCD-400AZT-H/N 4"Vandal dome	4~9mm Vari-focal zoom auto iris & D/N filter	1/3"sony super-had color CCD	Day-true color/ Night-0.0001 lux	Indoor Outdoor	
VCD-400T-H/N 4"Vandal dome	6.0mm Fixed D/N filter	Same	Same	Indoor Outdoor	
VCD-400-L3.6 4"Vandal dome	3.6mm Fixed "IR"filter	1/3"sony super-had color	D/N-0.01 lux	Indoor Outdoor	
VBD-400-L3.6 4"Vandal dome	3.6mm Fixed "IR"filter	1/3"sony super-had B/W	D/N-0.01 lux	Indoor Outdoor	
YCD-400AZT-SDN 4"Vandal plastic dome	4~9mm Vari-focal zoom auto iris & D/N filter	1/3"Sony super-had color	Day-true color/ Night-0.0001 lux	Indoor only	
YCD-400T-SDN 4"Vandal plastic dome	6.0mm Fixed D/N filter	1/3"Sony super-had color	Day-true color/ Night-0.0001 lux	Indoor only	
YCD-400-SDN 4"Vandal plastic dome	3.6mm Fixed "IR" filter	1/3"Sony super-had color ccd	0.01 Lux D/N	Indoor only	
YBD-400-SS	3.6mm Fixed	1/3"B/W ccd	0.05 Lux	Indoor only	
YCD-500-AZT-4/9 5"Shutter Dome	4-9 vari-focal zoom auto iris & D/N filter	1/3" Sony super-had ccd	Day-true color/ Night-0.0001 lux	Indoor only	
YCD-500W-AZT-4/9 "Wall mount"	4-9 vari-focal zoom auto iris & D/N filter	1/3" Sony super-had ccd	Day-true color/ Night-0.0001 lux	Indoor Outdoor	
YCC-690CW-AZT-6/15	6-15 Vari-focal zoom auto iris & D/N filter	1/3" sony super-had ccd	Day-true color/night-0.0001 lux	Indoor outdoor	
YCC-690CW-AZT-5/50 "Bullet acetal"	5-50 vari-focal zoom auto iris & D/N filter	1/3" Sony super-had ccd	Day-true color/ Night-0.0001 lux	Indoor Outdoor	
YCC-690CW-AZN-5/50 "Bullet metal"	5-50 Vari-focal zoom auto iris color	1/3" Sony super-had ccd	0.1 Lux-Nomal 0.01 Lux-"IR"	Indoor Outdoor	
YCC-690CW-MZN-5/50 "Bullet metal"	5-50 Vari-focal zoom electronic iris, color	1/3" Sony super-had ccd	0.5 Lux-Nomal 0.05 Lux-"IR"	Indoor Outdoor	
YBC-690CW-AZN-5/50 "Bullet metal"	5-50 Vari-focal zoom auto iris B/W	1/3" Sony super-had ccd	0.1 Lux-Nomal 0.01 Lux-"IR"	Indoor Outdoor	
YBC-690CW-MZN-5/50 "Bullet metal"	5-50 Vari-focal zoom electronic iris, B/W	1/3" Sony super-had ccd	0.5 Lux-Nomal 0.05 Lux-"IR"	Indoor Outdoor	

H. invisible or visible IR illuminator with CdS sensor to on-off illuminator about 10.0 lux automatically  
100% Weather-proof metal case with bracket to use indoor/outdoor, Family with A, B, C, D, E, F.



Model No	Leds	Image pick-up	Installation
YIL-24DS-950	24-950NM	10M-visible	Indoor/Outdoor
YIL-24DS-850	24-850NM	10M-clean	Indoor/Outdoor
YIL-56DS-950	56-950NM	20M-visible	Indoor/Outdoor
YIL-56DS-850	56-850NM	20M-clean	Indoor/Outdoor



YIL-104DS-950	56-950NM	30M-visible	Indoor/Outdoor	
YIL-104DS-850	56-850NM	30M-clean	Indoor/Outdoor	
YIL-104FS-850	104-850NM	50M-Clean	Indoor/Outdoor	
YIL-1000FH-264DS	264-850NM	200M-Clean	Indoor/Outdoor	

✘Remarks: Image pick-up distance acceptable by x27 Zoom day-night cameras, Vari-focal zoom day-night cameras, Fixed lens day-night cameras such as group **A, B, D, E, F** series models

I. Outdoor housing with fan & heater professional CCTV cameras to use hot & cold area  
 Builtin 4~9mm/5~50mm Vari-focal zoom or x27 Optical zoom with  
 x10 Digital zoom plus digital motion detector  
 Builtin RS-485/Pelco-D to use 255 zoom cameras Multi-remote control of  
 Zoom/Focus/Menu by DVR, Pelco-D controller "IR"remocon-optional  
 Internet CCTV observation with Zoom/Focus/Menu control by Client PC or DVR by using  
 Network video server (NVS-100Z) to use traffic monitoring-optional

Model no	Lens	Image pick-up	Dimensions	Installation	
LVC-1800AZT-4090FH	4~9 Vari-focal auto iris & D/N filter	Visible image 0.0001 lux at night	180(W)x150(H)x5 40(D)mm (7.08"x5.90"x21.25") 12kgs	Indoor/Outdoor Builtin fan & heater	 "Internet CCTV monitoring with zoom control by client PC, DVR by using Network video server (NVS-100Z) such as traffic, street CCTV cameras"- Optional 
LVC-1800AZT-5050FH	5-50 Tele-photo auto iris & D/N filter	Visible image 0.0001 lux at night	180(W)x150(H)x5 40(D)mm (7.08"x5.90"x21.25") 12kgs	Indoor/Outdoor Builtin fan & heater	
LVC-1800AZT-5050FH-104DS	5-50 Tele-photo zoom auto iris & D/N filter plus 104-Strong IR illuminator	50M(150Ft)-Clean image pick-up at night	180(W)x150(H)x5 40(D)mm (7.08"x5.90"x21.25") 12kgs	Indoor/Outdoor Builtin fan & heater	
LVC-1800DN-270x	X27 Optical zoom with x10 digital zoom & D/N filter	Visible image pick-up 0.01 lux by D/N filter at night	180(W)x150(H)x5 40(D)mm (7.08"x5.90"x21.25") 12kgs	Indoor/Outdoor Builtin fan & heater RS-485/Pelco-D	
LVC-1800DN-270x-104DS	X27 Optical zoom with x10 digital zoom & D/N filter Plus 104-strong IR illuminator	50M(150Ft)-Clean image pick-up at night	180(W)x150(H)x5 40(D)mm (7.08"x5.90"x21.25") 12kgs	Indoor/Outdoor Builtin fan & heater RS-485/Pelco-D	

J. Day-true color/Night-0.000 lux night vision by day-night filter plus strong IR illuminator about 10.0 lux automatically.(Camera & Illuminator together)  
 Builtin CdS sensor circuits to on-off illuminator about 10.0 lux & long life Illuminator by +12V regulator circuits, Super sensitivity by power boost circuits.  
 Builtin RS-485/Pelco-D to use 255-Zoom cameras multi-remote control of Zoom/Focus/Menu by DVR, Pelco-D controller, "IR" remocon (optional)  
 Internet CCTV observation & Zoom/Focus/Menu control by Client PC or DVR by using  
 Network video server (NVS-100Z) to use traffic monitoring-optional

Model No	IR leds	Image pick-up at night time	Dimensions	Installation	
----------	---------	-----------------------------	------------	--------------	--

LVC-2700DNFH-250DS RS-485/Pelco-D	850NM	100M(300Ft) clean x27 zoon day-night	Φ150-224mm Φ5.9"-8.81"	Indoor Outdoor	      
LVC-2700AZTFH-250DS Long distance	850NM	150M(45Ft) clean 5-50mm vari-focal	Φ150-224mm Φ5.9"-8.81"	Indoor Outdoor	
LVC-940DNFH-94DS RS-485/Pelco-D	850NM	50M(150Ft) clean x27 zoon day-night	Φ94-187mm Φ3.70"-7.36"	Indoor Outdoor	
LVC-940AZTFH-5/50-80DS Medium distance	950NM 850NM	50M(150Ft) clean 100M(300Ft) clean 5-50mm tele-photo auto iris lens & D/N filter	Φ94-133mm Φ3.70"-5.23	Indoor Outdoor	
LVC-940AZT-4/9-80DS Medium distance	950NM	50M(150Ft)-clean 4-9mm Vari-focal & auto iris & D/N filter	Φ94-133mm Φ3.70"-5.23	Indoor Outdoor	
LVC-940AZT-4/9-80HS Medium distance	850NM	100M(300Ft)-clean 4-9mm Vari-focal & auto iris & D/N filter	Φ94-133mm Φ3.70"-5.23	Indoor Outdoor	
LVC-750RW-AZT-4/9-32DS "Bullet metal"	850NM	50M(150Ft) clean 4-9mm vari-focal Auto iris & D/N filter	Φ75-170mm Φ2.95"-6.69"	Indoor Outdoor	
YCC-690RW-AZT-4/9-32DS "Bullet metal"	950NM	20M(60Ft) clean 4-9mm vari-focal Auto iris & D/N filter	Φ69-90mm Φ2.91"-3.54"	Indoor Outdoor	
YCC-690RW-AZT-4/9-32HS "Bullet metal" "D/N filter"	850NM (Strong)	30M(90Ft) clean 4-9mm vari-focal Auto iris & D/N filter	Φ69-90mm Φ2.91"-3.54"	Indoor Outdoor	
YCC-690CW-AZT-6/15-32DS	950  850	20M(60Ft) Clean 6- 15mm Vari-focal auto iris & D/N filter 40M(120Ft) Clean	Φ69-90mm Φ2.91"-3.54"	Indoor Outdoor	
YCC-690CW-AZT-6/15-32HS	850 (Strong)	Same above 40M(120Ft) clean	Φ69-90mm Φ2.91"-3.54"	Indoor Outdoor	
YCC-520TW-22DS "D/N Filter"	950NM 850NM	10M(30Ft) clean 20M(60Ft) clean	Φ50-67.5mm Φ1.96"-2.65"	Indoor Outdoor	
YCC-690TW-54DS "D/N Filter"	950NM 850NM	20M(60Ft) clean 30M(90Ft) clean	Φ69-67.5mm Φ2.91"-2.65"	Indoor Outdoor	
YCC-940TW-102DS "D/N Filter"	950NM 850NM	30M(90Ft) clean 50M(150Ft) clean	Φ94-67.5mm Φ3.70"-2.65"	Indoor Outdoor	
LVC-3000HDN-96DS "Bullet metal"  Digital slow shutter	950NM	30M(90Ft) clean 50M(150Ft) visible X27 Zoom day-night 0.0001 lux	Φ94-119mm Φ3.70"-4.68"	Indoor Outdoor  Optional	
VCD-400AZT-32HS 4" Vandal dome	850NM (Strong)	30M(90Ft) clean 4-9 Vari-focal Auto iris & D/N filter	Φ100-115mm Φ4.0"-4.52"	Indoor Outdoor	
VCD-400AZT-32DS 4"Vandal dome	950NM (Invisible )	20M(60Ft) clean 4-9 Vari-focal Auto iris & D/N filter	Φ100-115mm Φ4.0"-4.52"	Indoor Outdoor	
YCD-400AZT-32DS 4"Vandal plastic dome	950NM (Invisible )	20M(60Ft) clean 4-9 Vari-focal Auto iris & D/N filter	Φ100-115mm Φ4.0"-4.52"	Indoor	
YCD-400AZT-32HS 4"Vandal plastic dome	850NM (Strong)	30M(90Ft) clean 4-9 Vari-focal Auto iris & D/N filter	Φ100-115mm Φ4.0"-4.52"	Indoor	

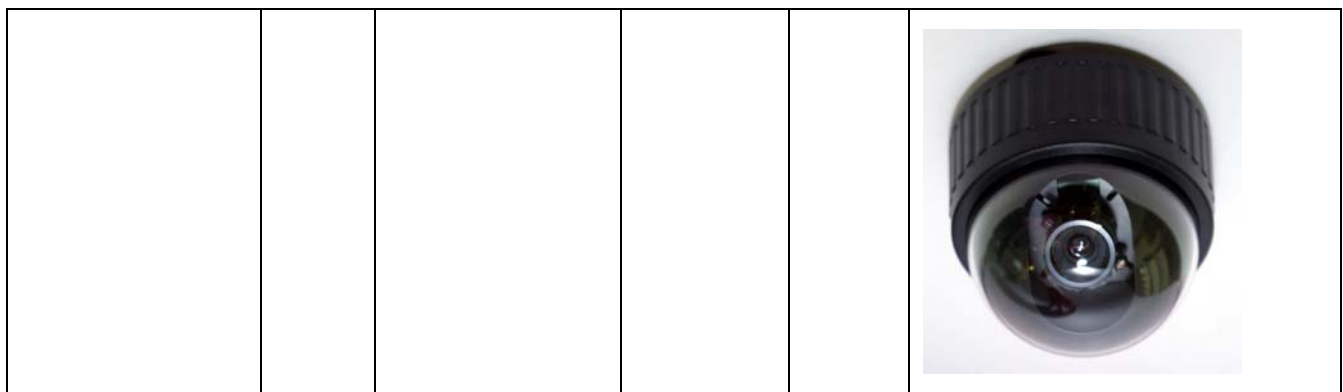

K. Day-color/Night-0.000 lux night vision by IR filter plus IR illuminator at night automatically  
 Builtin CdS sensor circuits to on-off illuminator about 10.0 lux & long life illuminator by +12V  
 regulator circuits, Super sensitivity by power boost circuits to make EX-view sensitivity  
 Internet CCTV observation by Client PC or DVR by using Network video server (NVS-  
 100PTZ) to use traffic, office, home monitoring - optional

Model No	IR leds	Image pick-up at night time	Dimensions	Installation
YCC-520RW-24DS "BULLET METAL"	950NM 850NM	10M(30Ft) visible 10M(30Ft) clean	Φ50-67.5mm Φ1.96"-2.65"	Indoor Outdoor
YCC-690RW-56DS "BULLET METAL"	950NM 850NM	20M(60Ft) visible 20M(60Ft) clean	Φ69-67.5mm Φ2.91"-2.65"	Indoor Outdoor
YCC-940RW-104DS "BULLET METAL"	950NM 850NM	30M(90Ft) visible 30M(90Ft) clean	Φ94-67.5mm Φ3.70"-2.65"	Indoor Outdoor
YBC-500RW-S25DS "B/W Bullet"	950NM 850NM	10M(30Ft) visible 10M(30Ft) clean	Φ50-67.5mm Φ1.96"-2.65"	Indoor Outdoor
YBC-690RW-S56DS "B/W Bullet"	950NM 850NM	20M(60Ft) visible 20M(60Ft) clean	Φ69-67.5mm Φ2.91"-2.65"	Indoor Outdoor
YBC-940RW-S104DS "B/W Bullet"	950NM 850NM	30M(90Ft) visible 30M(90Ft) clean	Φ94-67.5mm Φ3.70"-2.65"	Indoor Outdoor
YCC-300RW-7DS Micro Bullet	950NM 850NM	5M(15Ft) visible 5M(15Ft) clean	Φ30-97.0mm Φ1.18"-3.81"	Indoor Outdoor
LVC-250DNFH-250DS-L25 Long distance	850NM	100M(300Ft) clean	Φ150-224mm Φ5.9"-8.81"	Indoor Outdoor
LVC-940RW-96DS-L25 Medium distance	850NM	50M(150Ft) clean	Φ94-187mm Φ3.70"-7.36"	Indoor Outdoor
LVC-750RW-40DS Medium distance	850NM	30M(150Ft) clean	Φ75-170mm Φ2.95"-6.69"	Indoor Outdoor
VCD-400-40DS VCD-400-40HS 4"Vandal dome	950NM 850NM	20M(60Ft) visible 20M(60Ft) clean	Φ100-115mm Φ4.0"-4.52"	Indoor Outdoor
YCD-400—24DS YCD-400-24HS 4"Vandal plastic dome	950NM 850NM	20M(60Ft) visible 20M(60Ft) clean	Φ100-115mm Φ4.0"-4.52"	Indoor
YCD-500-40DS 5"DOME	950NM 850NM	20M(60Ft) visible 20M(60Ft) clean	Φ120-100mm Φ4.72"-3.93"	Indoor





YCD-500W-40DS 5"DOME	950NM 850NM	20M(60Ft) visible 20M(60Ft) clean	Φ120-100mm Φ4.72"-3.93"	Wall mount Indoor Outdoor	
-------------------------	----------------	--------------------------------------	----------------------------	---------------------------------	--

**L. Super sensitivity micro bullet color or b/w camera, Ultra miniature color or B/W cameras**

Model no	Description	
YCC-300RW-7DS	Φ30mm Weather-proof micro bullet day-color/night-0.00 lux B/W	
YCC-300RW-25	Same above with 25mm tele-photo lens to good image pick-up 30M(150Ft)	
YCC-300RW-6.0	Same above with color fixed lens	
YCC-270LW-25	1/4" sharp color ccd micro bullet 25mm tele-photo zoom fixed lens	
YCC-270LW-3.6	Same above with color fixed lens	
YCC-190LW-L3.6	1/3" Sony super-had color, 0.5 lux	
YBC-020LW-25	1/3" B/W ccd micro bullet 25mm tele-photo fixed lens	
YBC-020LW-3.6	Same above with B/W fixed lens	
YUC-3030CP/FP	Ultra miniature color, 1/4" sharp color ccd	
YUB-2525CP/FP	Ultra miniature B/W, 1/3" Samsung B/W ccd	

**M. Super sensitivity micro board cameras-0.005 lux by power boost circuits to make EX-view ccd.**

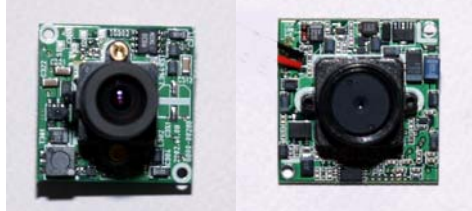
Model no	Description	
YMC-3232FP	Color flat pinhole lens, 32x32-1 board, 0.005 lux	
YMC-3223CP	Color cone pinhole lens, Same above, 0.005 lux	
YMB-3232FP	B/W flat pinhole lens, 32x32-1 board, 0.005 lux	
YMB-3232CP	B/W cone pinhole lens, 32x32-1 board, 0.005 lux	
YMC-3030FP	1/4" sharp color ccd flat pinhole with mic, , 0.5 lux	
YMC-3030CP	1/4" sharp color ccd cone pinhole with mic, , 0.5 lux	

**N. Professional dummy camera with interval flashing LED on-off circuits automatically**

MODEL NO	DESCRIPTION	
YDM-450BX	Box type plastic case to use indoor 54(W)x40(H)x116(D)mm / (2.12"x1.57"x4.56") 6-Month operating time by 2-"A" batteries	
YCD-400DM	4" Dome type to use indoor Φ100-70mm(Φ4.0"x2.75") 6-Month operating time by 2-"A" batteries	
YDM-750RW	100% Weather-proof metal case with sun shield & braket to use indoor/outdoor Φ75-190mm(Φ2.95"x7.48") 6-Month operating time by 2-"A" batteries	

**O. 100% Under-water color or B/W cameras more than 50M(150Ft) inside water  
100% Water-proof cable 10M, 50M, 100M, 200M (optional)**

Model No	Camera	Case material	Dimensions	
YCC-2000LWW-6S	1/4"Color ccd with 6-white lamp	Metal case Epoxy bond	Φ20-72mm Snake color cameras	
YBC-2000LWW-6S	1/3"B/W ccd with 6-white lamp	Metal case Epoxy bond	Φ20-62mm Snake B/W cameras	
YCC-300LWW-6S	1/3"Sony super-	Metal case	Φ30-80mm	

	had color	Epoxy bond	Miniature
YCC-300LWW-6GLS	1/3"Sony super-had color	Metal case Epoxy bond	Φ30-80mm 5M-glass rod 1.2M-folded
YCC-350LWW-6S	1/3"Sony super-had color	Metal case Epoxy bond	Φ34-78mm Miniature
YCC-350LWW-6GLS	1/3"Sony super-had color	Metal case Epoxy bond	Φ34-78mm 5M-glass rod 1.2M-folded
YBC-350LWW-6S	1/3"Sony super-had B/W	Metal case Epoxy bond	Φ34-48mm B/W standard
YCC-650LWW-45S "Strong light"	1/3"Sony super-had color	Acetal case Epoxy bond	Φ65-57.5mm Chemical pool
YCC-650LWW-45GLS	1/3"Sony super-had color	Acetal case Epoxy bond	Φ65-57.5mm 5M-glass rod 1.2M-folded
YBC-650LWW-40S "Strong light"	1/3"Sony super-had B/W	Acetal case Epoxy bond	Φ65-57.5mm Chemical pool
YCC-5000WW-27S "Strong light"	X16 Auto zoom color camera 410K, 480TVL	Acetal case Epoxy bond Metal case	Φ71-123mm Chemical pool Inside water
YCC-5000WW-27GLS "Strong light"	X16 Auto zoom color camera 410K, 480TVL	Acetal case Epoxy bond Metal case	Φ71-123mm 5M-glass rod 1.2M-folded
YCC-7000WW-48S "Strong light"	X22 Auto zoom color camera 410K, 480TVL	Metal case Epoxy bond	Φ82-123mm Inside water
YCC-7000WW-48S-D/N "Strong light" Day-night filter	X27 Auto zoom day-night Night-0.01lux B/W 410K, 480TVL	Metal case Epoxy bond	Φ82-123mm Inside water
YCC-7000WW-48GLS "Strong light"	X22 Auto zoom color camera 410K, 480TVL	Metal case Epoxy bond	Φ82-123mm 5M-glass rod 1.2M-folded
LVC-3000HDNW-96HS "Strong IR light"	X27 Auto zoom day-night Night-0.01lux B/W 410K, 480TVL	Metal case Epoxy bond "AL or BRASS" -optional	Φ98-187mm 50M- Inside water or sea
YUC-10	10M(30Ft)-Under-water cable with water-proof receptacle to use 50m(150Ft) inside water or sea		
YUC-30	Same above with 30M(90Ft)		
YUC-50	Same above with 50M(150Ft)		
YRL-10	10M(30Ft)-Under water cable with wheel assy		
YRL-30	30M(90Ft)-Under water cable with wheel assy		
YRL-50	50M(150Ft)-Under water cable with wheel assy		
YST-350LWW-5.6"	AL-suit case with 5.6" color LCD monitor plus recharge battery & circuits		
YST-350LWW-10.4"	Same above with 10.4" color LCD monitor		
YDC-10002HL	Diver's under-water color camera with 100M(300Ft) urethane cable with 2-4W halogen lamp		

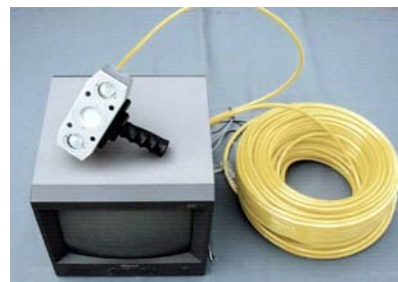

P. Power zoom magnification cameras to use low vision or visually impaired.

Flexible or table type bracket & X-Y moving table – optional

Model no	Description
LVC-1000HM +5.00/+3.50	x5~x50 Power zoom magnification by +1.00 swing away macro lens to use leading & writing plus long distance leading letters on blackboard by open of swing away lens at school. Included camera mounting bracket Builtin wireless(IR) remocon to remote control of all function
MVS-1000HM	Same above with X-Y moving table to easy reading or writing
LVC-2200HM +5.00/+3.50	x5~x60 Power zoom magnification by +5.00 macro lens to use leading & writing, builtin wired remocon
MVS-300 -10x/30x	x10~x30 magnification color camera to use reading only. Large/Small/Negative/Color/Power control button Builtin 6-white leds lamp
MVS-300RW -10x/30x	x10~x30 magnification color camera with fixable arm bracket to use reading & writing,
MVS-100-10x	x10 fixed magnification color camera with flexible arm bracket to use reading & writing, builtin 6-white leds lamp
MVS-150-10x	x10 fixed magnification color camera to use reading only Builtin 6-white lamp, economic price!!!
YIC-1000VGA	4CH. Image capture & compare with still or moving image VGA input/output to use PC or VGA monitor
YST-560-5.6" YST-560-10.4"	AL-suit case with 5.6" or 10.4" color TFT LCD monitor to use above all magnification cameras
YTM-560	5.6" Color LCD monitor w/t bracket
YTM-104	10.4" Color LCD monitor w/t bracket
LG-110A	X-Y line moving generator to use easy reading of book to use low vision or visually impaired.



Q. Additional items

Model no	Description
YDR-401/WEB	4CH. Standalone DVR or with WEB server
YMD-11	Digital motion detector to use all CCTV cameras
VAMS-0808	8CH. Video/audio matrix switcher
YTX-310/YRX-310	2.4GHz TX/RX 4CH.-Manual selection
YRA-100	2.4GHz RF AMP. 100mW output
YRA-300	2.4GHz RF AMP. 300mW output
YRA-500	2.4GHz RF AMP. 500mW output
HPW-2400Y	2.4GHz Yagi-antenna, +16dB Weather-proof case to use outdoor
HWPT-2350A	2.4GHz Patch-antenna, +12dB Weather-proof case to use outdoor
YRT-960HR	Joggle shuttle 40HR real time with 960HR TLR
YMV-960HR	Mobil vision 40HR real time with 960HR TLR (DC12V)
YEV-1000	Event recording VCR
YH-1610F	16CH. Real time multiplexor, 5-output (720x480)
YH-910F	9CH. Real time multiplexor, 3-output (720x480)
YCM-1400	Professional 14" color monitor Metal case, NTSC/PAL auto switchable
YCM-1400Q	Same above with real time QUAD



YCM-2100	Professional 21" color monitor NTSC/PAL auto switchable	 
YRB-300	Rechargeable battery pack, DC12V/3.0AMP.	
JI-88H	Garett type hand held metal detector	
JI-89A	Standard type hand held metal detector	
JI-89H	Long stick type hand held metal detector	
JI-90H	Miniature hand held metal detector	
PC-1200	Wake-through Metal detector with bar LEDS indicator	
VP-8320	8-In/32-Out Video distributor & amplifier	
YVS-04	4ch.-Video switcher, Auto/Manual with amplifier	
YVS-08	8ch.-Video switcher, Auto/Manual with amplifier	
DMS-100	x50, x200, x500 Interchangeable magnification lens video microscope with leds lamp & height control stand to inspection of integrated circuits(IC) , micro parts, microorganism, finger wave, skin treatment, etc.  1/3" Sony super-had color CCD camera, 410K/480TVL lens DC12C/500mA (3.0Watts)	

## R. ACCESSORIES CABLE ASSY

MODEL NO	DESCRIPTION		
YCB-2	Y-CABLE, DC JACK TO 2-DC PLUG		
YCB-3	W-CABLE, DC JACK TO 3-DC PLUG		
YRC-10	10M(30Ft) DC JACK/RCA PLUG/RCA PLUG TO DC PLUG/RCA PLUG/RCA PLUG ASSY		
YRC-20	20M(60Ft) DC JACK/RCA PLUG/RCA PLUG TO DC PLUG/RCA PLUG/RCA PLUG ASSY		
YRC-30	30M(90Ft) DC JACK/RCA PLUG/RCA PLUG TO DC PLUG/RCA PLUG/RCA PLUG ASSY		
YWC-18	18M(30Ft) WEATHER-PROOF CABLE ASSY		
YWC-DRC	0.5M(1.5Ft) WEATHER-PROOF JACK TO DC/RCA/RCA/RCA CONVERTOR, FAMILY WITH YWC-18		

## S. CAMERAS MOUNTING BRACKET

MODEL NO	DESCRIPTION			
YBL-45	STREIGHT TYPE, L-45mm			
YBL-60	STREIGHT TYPE, L-60mm			
YBL-115	STREIGHT TYPE, L-115mm			
YCB-100	CLAMP TYPE: L-130mm			
YIB-100	I-SHAPE HEAVY DUTY: L-150mm			
YBL-1000	1M LONG STREIGHT TYPE: L-1000mm			



Connection diagrams of 255-P/T/Z cameras multi-remote control by DVR, computer, Remocon

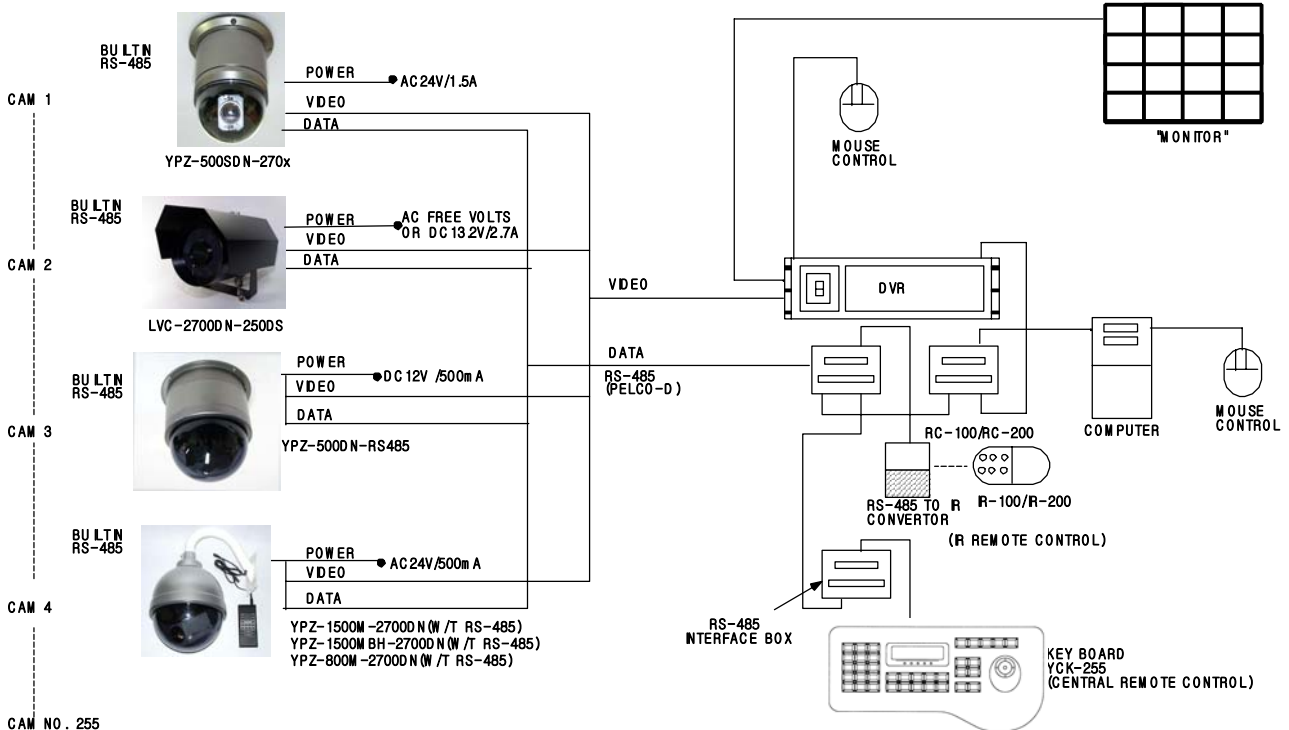

© Built RS-485 Pan/Tilt/Zoom or Zoom cameras such as YPZ-500SDN-270x, YPZ-5000N-270x, YPZ-800M, YPZ-1500M BH, LVC-2700N-250DS, LVC-940N-94DS, etc.

38 Years Experienced



SFE - UNITEL - SERVICE COMMERCIAL

B.P.27 - 83 180 - SIX-FOURS Cedex

Tel: 04 94 25 10 60 Fax: 04 94 25 10 02

WEB: <http://www.sfe-france.com/>

E mail: [sfe83@sfe-france.com](mailto:sfe83@sfe-france.com)

**Société Française d' Emetteurs**

SARL au capital de 30 489.80 € - R.C.S. TOULON - SIRET 385 125 984 00026

Siège social : 21 av. des Dahlias - 26290 DONZERE